



Engineering Ltd

Side Entry Doughty Clamps



User Manual

IMPORTANT – READ CAREFULLY BEFORE USE – KEEP FOR FUTURE REFERENCE

User Manual Revision A Issued August 2018

Doughty Engineering Ltd
Crow Arch Lane, Ringwood, Hampshire BH24 1NZ
Tel: +44 (0) 1425 478961

sales@doughty-engineering.co.uk
www.doughty-engineering.co.uk

Contents

- 1. SAFETY NOTES..... 3
- 2. GENERAL..... 3
- 3. SCOPE..... 4
- 4. LIMITATIONS OF USE..... 4
- 5. IDENTIFICATION OF THE PRODUCT..... 6
- 6. MODIFICATION..... 7
- 7. SAFETY INFORMATION 7
- 8. COMPLIANCE..... 10
- 9. TRANSPORT AND STORAGE 10
- 10. INSTALLATION..... 10
- 11. COMMISSIONING..... 12
- 12. DISSASSEMBLY INSTRUCTION..... 12
- 13. INDICATIONS OF FAULTS 12
- 14. INSPECTION, DISCARD AND REJECTION CRITERIA 12
- 15. MAINTENANCE..... 14
- 16. REPAIRS and REPLACEMENT OF PARTS..... 14
- 17. IF THE PRODUCT IS NO LONGER NEEDED 14
- 18. WARRANTY 14
- 19. INSPECTION LIST 15
- 20. EC DECLARATION..... 16

1. SAFETY NOTES

BEFORE installing and operating clamps, please read this manual carefully and pay attention to the information provided. Use this manual to familiarise yourself with the clamp, its proper use and safety regulations.

DANGER

DANGER: Indicates a hazardous situation which, if not avoided, will result in death or serious injury. This signal word is to be limited to the most extreme situations.

WARNING

WARNING: Indicates a hazardous situation which, if not avoided, could result in death or serious injury.

CAUTION

CAUTION: Indicates a hazardous situation which, if not avoided, could result in minor or moderate injury.

NOTICE

NOTICE: address practices not related to personal injury.

SAFETY INSTRUCTIONS

SAFETY INSTRUCTIONS: is used for lists of steps, procedures or instructions that might otherwise substitute a DANGER, WARNING or CAUTION notification.

2. GENERAL

The Side Entry Doughty Clamp range consists of various clamps used to lift loads or make structural connections. Clamps are used in the entertainment market. They can be used for permanent support structures in places of entertainment such as museums, event venues, theatres etc.

Lifting loads is inherently dangerous so Side Entry Doughty Clamps are strictly for professional use only.

Only competent persons are permitted to install and use Side Entry Doughty Clamps. A competent person in this respect is an individual with relevant technical education, training and/or experience enabling him or her to perceive risks and to avoid hazards occurring during use of a product.

The load capacity differs depending on the model and the safety factor required. Clamps are suitable to fit steel and aluminium tubes of diameters ranging from 48mm to 51mm depending on the model. Clamps are marked with its working load limit for static loading. Most clamps are available in Silver (polished aluminium) or black powder coating.

Special attention has been taken to safety. Therefore the TUV test certificates indicate multiple Working loads. Depending on the application or local applicable legislation max working load can be chosen.

Clamps can be judged as a lifting accessories under the EU machine Directive 2006/42/EC as well as German DGUV-BGV-C1 for lifting and holding loads above persons. They can

also be used as a joining part in constructions. For this application no harmonised standard is available no CE Declaration of Performance can be provided.

Doughty has endeavoured to deliver the highest degree of accuracy possible. However, continuous improvement of our products is a Doughty Policy. Therefore, product specifications are subject to change without notice.

Readers and users are encouraged to notify Doughty of errors and send in suggestions for improvement. All communications will be carefully considered for future printings of this manual and changes to our products.

Some models of clamps are composed of different elements each with an individual Working Load. The lowest of the working loads determines the overall strength and thus shall be used as max working Load for the application.

When Side Entry Doughty Clamps form part of a lifting machine or lifting system, the lifting machine or system shall be tested and marked with its SWL and appropriate certification issued.

The resulting forces in the structure attached shall be verified before applying a load.

For the ease of reading this document the word “Clamps” or “Clamp” is used to cover all Side Entry Doughty Clamp series and models.

3. SCOPE

The intended use of clamps is to be used as a lifting accessory to hang loads or create a connection between structural elements. Loads can be, but not limited to, lighting fixtures, video projectors, sound systems and stage sets.

Structural elements can be pipes, trusses, tubular frame works or lifting brackets.

Any use other than that mentioned is considered to be a case of misuse. The user/operator and not the manufacturer shall be liable for any damage or injury resulting from such cases of misuse.

The use of clamps for scaffolding purposes under EN74 is explicitly excluded from the intended use.



Check local legislation for the application of use and adapt the use where ever necessary.

4. LIMITATIONS OF USE

- The Clamps can be operated in -20° Celsius up to +60° Celsius.
- Salt water environments require cleaning with fresh water at least once per week
- Side Entry Doughty Clamps shall only be used on steel or aluminium tubes or bars.
- When Side Entry Doughty Clamps are used as part of an outdoor lifting system, special factors such as ground condition and profile, wind loading, water accumulation on temporary structures and other criteria shall also be taken into account.

- When clamps are used to secure equipment which is moved or suspended over areas where persons are present an M12 self-locking nut shall replace the standard nut and wingnut.
- The use of Clamps is the sole responsibility of the user.
- To use the Clamps the user must also observe the safety regulation, the assembly and dis-assembly instructions to be found in this manual.
- All persons who use and service this device have to be acquainted with this manual and must be informed about its potential hazards.
- It is also imperative to observe the local accident prevention regulations and/or occupational health and safety regulations.
- The manufacturer is not liable for indirect consequential damage and financial loss. The manufacturer shall not be liable for any changes made to the device nor for any damage resulting from such changes.

Loading Table

Rated Load with a Safety Factor of 10:1 WLL₁ DGUV/BGV C1 for Lifting Load

Rated Load with a Safety Factor of 5:1 WLL₂ 2006/42/ES for Static Load

PART NO	TUBE DIA	DESCRIPTION	FINISH	ACCESSORY	WLL1 (KG) LIFTING (CE)	WLL2 (KG) STATIC
T58780	48-51	Side Entry Doughty Clamp	Polished	None	375	750
T58781	48-51	Slimline Side Entry Doughty Clamp	Polished	None	250	500
T58782	48-51	Side Entry Doughty Clamp	Black	None	375	750
T58783	48-51	Slimline Side Entry Doughty Clamp	Black	None	250	500

5. IDENTIFICATION OF THE PRODUCT

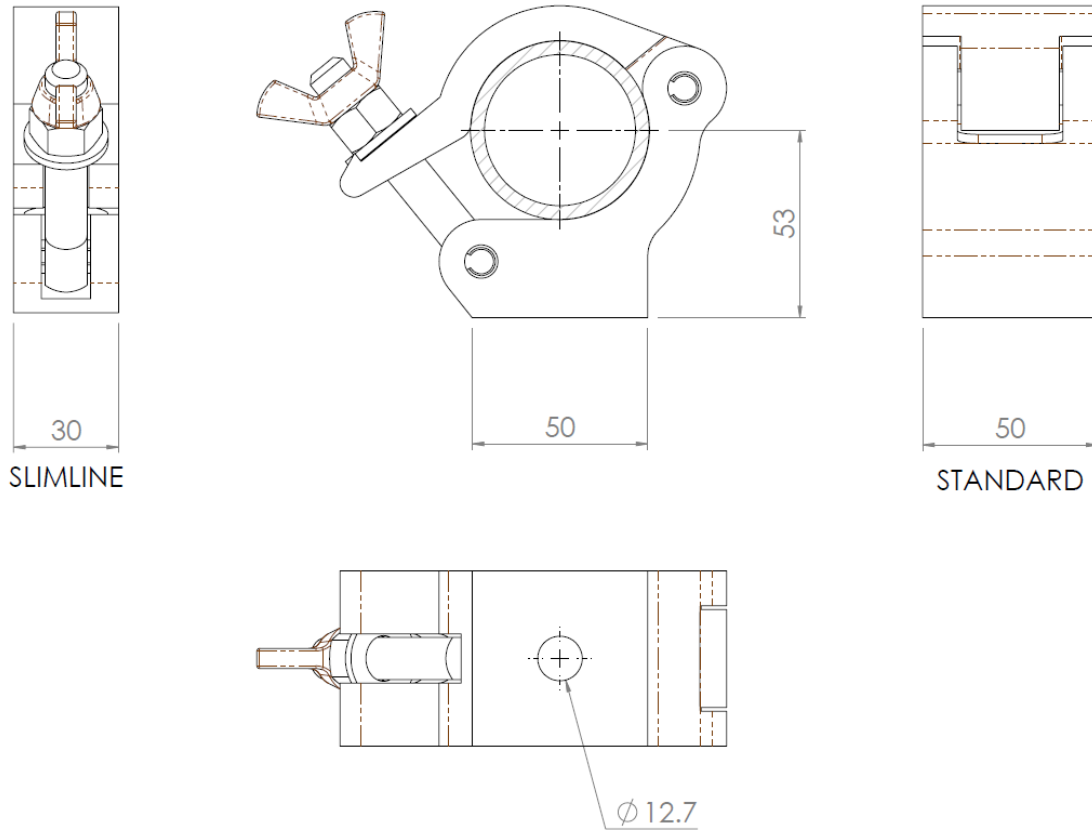

TYPICAL SIDE ENTRY DOUGHTY CLAMP

Part No — **T58780 - Ø48-51mm** — *Tube Diameter*

Works Order No — **Wo. 2021001**



Post Code — **BH24 1NZ, UK**

TUV Mark —   — *Read Instructions*

 — *CE mark*

Working Load Limit — **WLL 750kg**

TYPICAL SIDE ENTRY DOUGHTY CLAMP LABEL

6. MODIFICATION

The following *modifications are allowed to be executed by third parties.*

Nut replacement: *The standard nut and wing-nut shall be replaced by a self-locking nut when*

- Loads are predominantly dynamic.
- Loads are moving and change position.

Painting:

- To paint a clamp, cover all bolts and nut with tape.
- Use blasting to roughen the surface and to degrease the clamp.
- Use a wet-paint or powder coating paint system to colour the part.







7. SAFETY INFORMATION

SAFETY INSTRUCTIONS

For health and safety reasons people assembling, disassembling, transporting, maintaining and cleaning Clamps should wear adequate Personal Protection Equipment such as, but not limited to; gloves, hard hats and safety shoes.

WARNING

*DO NOT lift loads above people without the following precautions
Use a Self-locking nut instead of the wingnuts on the eye bolts when loads are predominantly dynamic and loads are moving and change position.*

-  Clamps shall be solely used for the range of pipe diameters as stated on the clamp. The use of a clamp on other diameter pipes will lower the working load limit.
-  Do not exceed the working load limit engraved on the clamp.
-  Make sure the resulting forces on the supporting structure are approved by a competent person.
-  All loads imposed shall be considered. E.g. dynamic forces caused by the lifting machinery.
-  Bolts and nuts shall be tightened by means of a spanner in such a manner they cannot be released by man power.
-  When loads are using electrical power, equip-potential bonding shall be put in place.

- ⚠ Clamps shall be inspected by a competent person as often as required but with a minimum of once a year.
- ⚠ Inspect equipment before every use. Damaged clamps shall be taken out of service.
- ⚠ A clamp must be taken out of service immediately if, during use, repair or maintenance any serious damage is discovered.
- ⚠ Maintenance and repairs can be undertaken only by authorised personnel. If in any doubt contact the manufacturer.
- ⚠ Do not throw clamps.

⚠ WARNING

THE WORKING LOAD ENGRAVED ON THE CLAMP IS SOLELY FOR A STRAIGHT PULL BETWEEN THE SUPPORTING PIPE AND CONNECTION POINT ON THE CLAMP

THE METHODS OF SUSPENSION SHOWN BELOW CREATES TORSIONAL FORCES, INFLUENCE THE STABILITY OF THE SUPPORTING STRUCTURE AND LOWERS THE WORKING LOAD OF THE CLAMP. THIS NEEDS TO BE CHECKED BY A COMPETENT PERSON.

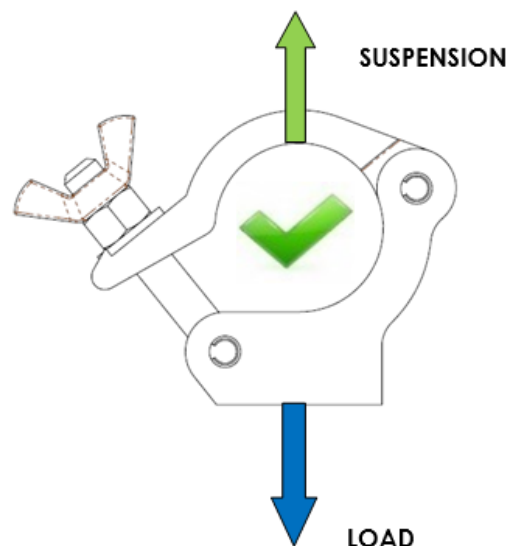

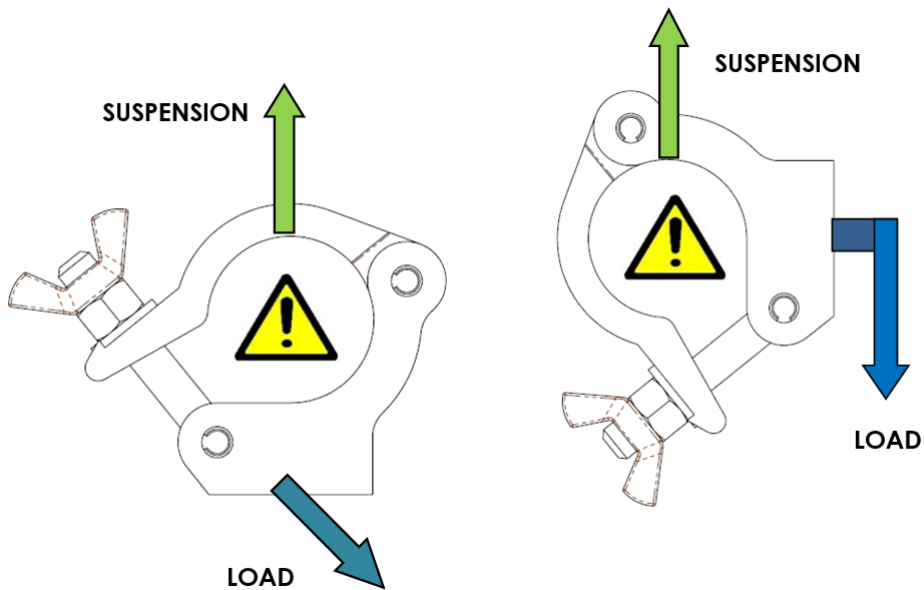

⚠ WARNING

USING CLAMPS WHERE THE DIRECTION OF LOAD IS PARALLEL TO THE TUBE DEPENDS ON, BUT NOT LIMITED TO, CONTACT SURFACE, MATERIAL, FRICTION RESISTANCE AND THE APPLIED TORQUE TO THE CLAMP'S WINGNUT / NUT. THIS TYPE OF APPLICATION SIGNIFICANTLY REDUCES THE STATED WLL AND SHOULD BE USED WITH EXTREME CAUTION.

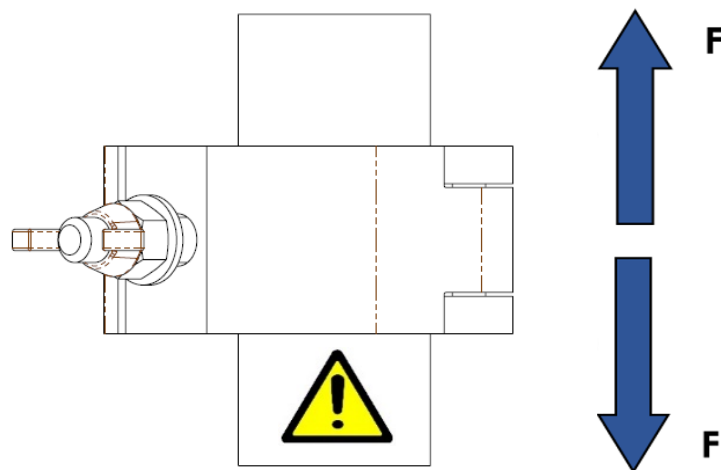

⚠ Do not use fixings that, when tightened, will contact the tube or barrel on which the clamp is fixed as highlighted above.

8. COMPLIANCE

CLAMPS USED AS LIFTING ASSESSORY:

2006/42/EC	Machinery directive
DGUV Rules 115-002	Regulations for stages and studios (Formerly known as BGVc1)
DGUV Information 215-313	Safety at productions and events for television, radio, film, theatre, exhibitions: Loads above persons (Formerly known as BGI 810-3)
BS 7905-1:2001	Lifting equipment for performance broadcast and similar applications. Part 1 specifications for the design and manufacture of above stage equipment

9. TRANSPORT AND STORAGE

- Due to the relatively high self-weight it is advised to keep storage bins as small as possible in such a manner they can be lifted by one person. Local legislation for maximum load to be lifted by persons shall be adhered to.
- Before clamps are put into storage they shall be checked for defects. Defective clamps shall be clearly marked and put aside in such a way they cannot be re-used.
- Put the lid and eye bolt together and hand tighten. This way bolts will not get lost during transport.
- Ensure the product is stored and kept in a dry, ventilated environment to avoid corrosion.
- Do not store aluminium clamps in steel bins.

10. INSTALLATION



Inspect the clamp before every use. If damaged do not use.

Side Entry Doughty Clamps

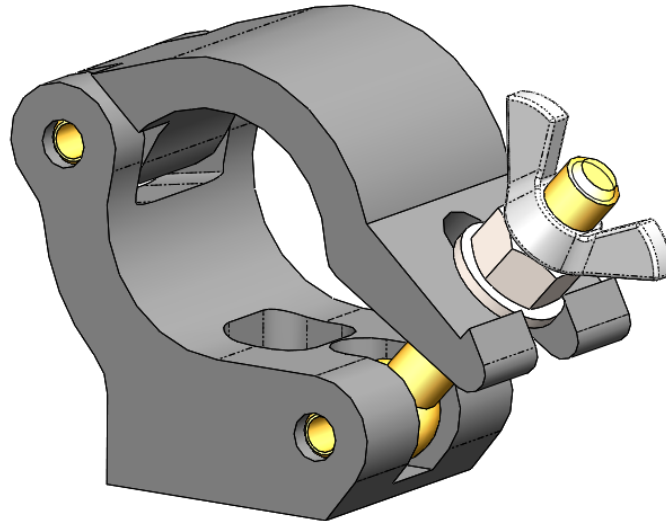

Side Entry Doughty Clamps are used to suspend or make structural connections between truss or barrel and a variety of objects using an M12 fixing.

- a. Determine the bolt type and length needed to connect the Side Entry Doughty Clamp to the object to be suspended.
- b. Use low head hexagon socket bolts or standard hexagon bolts. Minimum 8.8 grade.
- c. Tighten the bolt connection using the appropriate tool.
- d. Open the lid of the clamp.
- e. Fold the eye bolt and lid aside.
- f. Hang the clamp in the desired position. Tighten the bolt before the load is fully supported.
- g. Tighten the wingnut / nut / bolt by hand or using a 19mm spanner. Firmly hand tight should be enough. When using a spanner, do not apply a torque greater 30Nm /22lbft.
- h. Use a secondary safety if legislation requires.

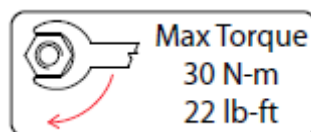



⚠ WARNING

Use an M12 self-locking nut instead of wing nut in case of overhead lifting.

⚠ WARNING

Over tightening the nut or bolt might lead to permanent deformation of the tubes to which they are attached.

11. COMMISSIONING

-  Before applying a load check that all connections are properly made.
-  Before lifting check that all connections are still correct.
-  Check if all parts are in good order.

12. DISSASSEMBLY INSTRUCTION

1. Take the weight of the clamp.
2. Release the nut and fold the eye bolt aside.
3. Open the lid and fold aside.
4. Remove the load.
5. Check if the clamps are in good order. If not, mark them clearly and put aside.

13. INDICATIONS OF FAULTS

The following faults could be an indication of overload or misuse. Remove those clamps from service.

- Deformation of the lid. (see diagram)
- Nuts which cannot be turned by hand.
- Eyebolt which do not swivel properly.
- Lid which do not swivel properly.
- Clamp does not fit around the pipe.

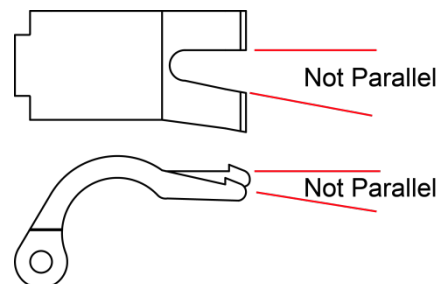

Typical Deformation Examples

14. INSPECTION, DISCARD AND REJECTION CRITERIA

WARNING

If any fault is found, mark the product clearly and remove from service.

14.1 INITIAL INSPECTIONS

When first acquired, whether they are new or used, clamps should be inspected in accordance with Table 1 and a record of the inspection maintained.

REGULAR INSPECTIONS

Regular visual inspections should be carried out in accordance with Table 1. Regular inspections should be performed by a competent person and should be carried out prior to each incident of use.

PERIODIC INSPECTIONS

Periodic visual inspections should be carried out in accordance with Table 1 and a record of the inspections maintained. Periodic inspections should be performed by a competent person and should be conducted at least once each year or in accordance with an inspection routine established by a qualified person.

Clamps which are subject to any accident must be inspected according to the requirements per periodic inspection and in accordance with table below.

14.2 INSPECTION FREQUENCY

CLAMPS IN REGULAR SERVICE

Clamps in regular service should be subjected to regular and periodic inspections.

PERMANENT INSTALLATIONS, STATIONARY

Periodic inspections should be carried out on all Clamps that are permanently installed in a stationary (not moving) configuration. The frequency of inspections should be determined on the basis of the prevalent conditions.

PERMANENT INSTALLATIONS, MOVING

Periodic inspections should be carried out every three months, or in accordance with an inspection routine established by a qualified person, on all clamps that are installed in a permanent configuration where movement of the truss system is an integral part of use.

RECORDS

Records of initial inspections and periodic inspections should be kept by the owner for each clamp and should be signed and dated by the person carrying out the inspections.

Table 1

	INSPECTION LEVEL			ITEMS TO BE INSPECTED					
	INITIAL	REGULAR	PERIODIC	LID	BODY	EYEBOLT	NUT	ROLL PIN	ID
MISSING PARTS	Y	Y	Y						Y
HOLES	Y	Y	Y	Y	Y				
ABRASION	Y	Y	Y	Y	Y			Y	
CORROSION			Y	Y	Y	Y	Y	Y	
DEFORMATION	Y	Y	Y	Y	Y	Y	Y	Y	
EXCESSIVE WEAR		Y	Y		Y	Y	Y	Y	
CRACKS	Y	Y	Y	Y	Y	Y	Y	Y	

15. MAINTENANCE

SAFETY INSTRUCTIONS

Although under normal use and environmental circumstances, clamps need little maintenance, for safety reasons, all parts must be checked regularly for damage, cracks and corrosion.

NOTICE

The Clamp shall be checked in compliance with the local law by a competent person. Checking shall take place as often as required but at a minimum of once a year. If in doubt contact the manufacturer.

- ⚠ Check all components for damage and corrosion. Damaged and corroded parts shall be removed and disposed of.
- ⚠ Check roll pins for cracks. If cracked, replace the pins.
- ⚠ Burrs and sharp edges shall be removed using fine sandpaper or a file.
- ⚠ Maintenance and repairs must only be carried out by a competent person. If in doubt, contact the manufacturer.
- ⚠ Do not use any mechanical abrasive machine to remove sharp edges from clamps.
- ⚠ Use hot water and soap to remove any dirt from clamps.
- ⚠ Do not use abrasive fluids to remove dirt or paint from clamps.

16. REPAIRS and REPLACEMENT OF PARTS

- Damaged clamps should be returned to an authorised Doughty service agent for repair.

17. IF THE PRODUCT IS NO LONGER NEEDED

Products that are no longer needed can be scrapped. Preferably remove all steel parts, store part separately before offering them to a scrapping company.

The following alloys are used:

- Aluminium ENAW 6060 or 6082
- Steel 8.8
- Stainless 304

18. WARRANTY

- For a period of 12 months we undertake to repair, free of charge any damage attributable to faulty materials or workmanship, provided that the appliance is forwarded, freight paid, to our works or one of the Doughty appointed service agents.
- The guarantee-period begins on the day of the delivery, proven by a purchase receipt like an invoice or delivery note or their copies.
- The guarantee only is applicable for new equipment.
- The guarantee does not cover damage due to transport damage, negligent handling, overload or parts subject to normal wear and tear. Nor damages that originate from a case of misuse because of non-observance the instructions in this manual.
- The fitting of non-original replacement parts or modifications of design by third parties invalidates the guarantee.
- Guarantee repairs do not renew nor extend the guarantee-period.
- In case of a claim under the guarantee or spare part requirements please contact your Doughty service agent.
- The manufacturer is not liable for indirect consequential damage or financial loss.
- The manufacturer is not liable for any changes made to the clamp or for any damage resulting from such changes.

19. INSPECTION LIST

ITEM	FAULT	REPAIR	DATE	SIGNATURE

20. EC DECLARATION



Doughty Engineering Ltd

Crow Arch Lane
Ringwood
Hants
BH24 1 NZ

Tel: 01425 478961
Fax: 01425 474481

sales@doughty-engineering.co.uk
www.doughty-engineering.co.uk

CE Declaration of Conformity according to Directive 2006/42/EC, Annex II 1A

Manufacturer

Doughty Engineering Ltd
Crow Arch Lane
Ringwood
Hampshire
BH24 1NZ

A copy of the Technical File is held at:

Doughty Engineering Ltd
Crow Arch Lane
Ringwood
Hampshire
BH24 1NZ

Description and identification of Lifting Accessory:

Description:- Side Entry Doughty Clamps and Slimline Side Entry Doughty Clamps.

Model:- T58780, T58781, T58782 & T58783

Max Load:- 750kg

Please note: All parts shown with a SWL are tested under factory conditions in a horizontal plane with the load straight down unless specified otherwise.

For parts used in a different orientation we would strongly advise that they are tested after installation by a competent person & a SWL issued by them.

Always remember - Any rigging product or combination of rigging products is only as strong as its weakest, or lowest SWL rated, parts.

We hereby declare that the above mentioned Lifting Accessory fulfils all the relevant provisions of EC Directive 2006/42/EC. This declaration relates exclusively to the Lifting Accessory in the state in which it was placed on the market, and excludes components which are added and/or operations carried out subsequently by the final user.

Harmonised Standards, Standards or specifications

BS EN ISO 12100:2010 Safety of Machinery, General principles for design, Risk Assessment and risk reduction

BS 7905-1: 2001 Lifting equipment for performance, broadcast and similar application

DGUV Regulation 17 Regulations for stages and studios. (Formerly known as BGVc1)

DGUV Information 215-313 Safety at productions & events for television, radio, film, theatre, exhibitions: Load above persons (Formerly known as BGI 810-3)

CWA 15902-1 European code of practice for lifting & Load bearing equipment for stages & other production areas within the entertainment industry

Signed for and behalf of: **Doughty Engineering Ltd**

Name: -

Position: - **General Manager**

Date: - **10-08-2018**

Being the person responsible appointed by the manufacturer.

Company Registration No. London 972614
Registered Office: Crow Arch Lane, Ringwood, Hants, BH24 1NZ
Directors: M.B. Lister. J.C.G. Chiverton. S.C. Wright.