

Source Four LED Series



Type(s)
Project
Date
Notes

GENERAL INFORMATION

The **Source Four LED Series 2** revolutionizes LED lighting. With optimized arrays and finely-tuned electronics, Series 2 offers a combination of light quality and output that cannot be matched.

Source Four LED Series 2 Lustr luminaires are based on the x7 Color System, utilizing seven colors including high-output lime to achieve true, usable broad-spectrum color with a depth and feel beyond any RGB fixture.

Series 2 light engines work with all Source Four lens tubes to deliver a high-quality, controllable beam of LED light. For the best results, we highly recommend that you use EDLT lens tubes. We also offer a special LED-only version of the 50° lens tube. Combine with available adapters to transform your fixture into a fully functional Fresnel or CYC light.

ORDERING INFORMATION

Source Four LED Series 2 Light Engine with Shutter Barrel

(For use with fixed-field lens tubes only)

MODEL	DESCRIPTION	ETL PART NUMBER	CE PART NUMBER	
S4LEDS2LS-0	Source Four LED Series 2 Lustr with shutter barrel, black	7461A1051	7461A1251	
S4LEDS2THDS-0	Source Four LED Series 2 Tungsten HD with shutter barrel, black*	DISCONTINUED	DISCONTINUED	
S4LEDS2DHDS-0	Source Four LED Series 2 Daylight HD with shutter barrel, black*	DISCONTINUED	DISCONTINUED	

Source Four LED Series 2 Light Engine Body

(For use with zoom lens tubes and retrofit of existing fixtures)

MODEL	DESCRIPTION	ETL PART NUMBER	CE PART NUMBER	
S4LEDS2L-0	Source Four LED Series 2 Lustr, body only, black	7461A1050	7461A1250	
S4LEDS2THD-0	Source Four LED Series 2 Tungsten HD, body only, black*	DISCONTINUED	DISCONTINUED	
S4LEDS2DHD-0	Source Four LED Series 2 Daylight HD, body only, black*	DISCONTINUED	DISCONTINUED	

Color options: -1 = white, -5 = silver gray/custom colors

Fixture ships with a soft-focus diffuser in a gobo holder and a 1.5 m powerCON® power-input cable with a connector of choice. See page 7 for connector options.

Please note: Lens tubes and c-clamp to be ordered separately.



PRODUCT SPECIFICATIONS

Source

LED details	60 Lumileds LUXEON® Rebel LED
Max lumens	Series 2 Lustr: 8,667 Series 2 Daylight HD: 13,060 Series 2 Tungsten HD: 11,512
Lumens per watt	Series 2 Lustr: 51.9 Series 2 Daylight HD: 52.7 Series 2 Tungsten HD: 55.3
L70 rating (hours to 70% output)	Lustr: 54,000 hours Daylight/Tungsten HD: >60,000 hours

Color

Colors used	Series 2 Lustr: Red, Amber, Lime, green, Cyan, Blue, Indigo Series 2 Daylight HD: Red, Mint, Blue, Indigo Series 2 Tungsten HD: Red, Red-Orange, Mint, Blue, Indigo
Color temperature range	Series 2 Lustr: 2,200–6,500 K*
Calibrated array	Yes
Red shift	Yes (can be disabled)

*Daylight HD is best suited for CT between 4000 and 6500 K. Tungsten HD is best suited for CT between 2700 and 4500 K.

Optical

Beam angle range	Swappable lens tubes between 5°–90°
Gate size	80 mm
Aperture size	6.25–14 in (depending on lens tube)
Pattern projection	Yes
Pattern size	A or B
Camera flicker control/Hz range	Yes: 900–25,000 Hz
Notes	Can be used with LED CYC and Fresnel adapters

Control

Input method	DMX512 via 5-pin XLR
Protocols	DMX512/RDM
Modes (footprint)	See page 8
RDM configuration	Yes
UI type	LCD
Local control	Yes
Onboard presets	Yes
Onboard sequences	Yes
Onboard effects	No
FixtureLink	Yes
Notes	15-bit virtual dimming engine

ETC utilizes a nationally recognized third-party lab for luminaire testing according to IES LM-84. See etcconnect.com/About/News/ETC-Fixture-Ratings-and-Warranties-Extended.aspx.

All LED sources experience some lessening of light output and some color shift over time. LED output will vary with thermal conditions. In individual situations, LEDs will be used for different durations and levels. This can eventually lead to minor alterations in color performance, necessitating slight adjustments to presets, cues or programs.

Electrical

Voltage range	100–240 VAC 50/60 Hz
Input method	Neutrik powerCON in and thru, requires power from a non-dimmable source
Inrush	50 A at 120 V (First half-cycle) 107 A at 240 V (First half-cycle)
Fixtures per circuit*	9 Lustr or 7 Daylight HD/Tungsten HD (15 A via power thru connector) 10 Lustr or 8 Daylight HD/Tungsten HD (via R20 module or Echo Relay Panel)
Wattage typical	Series 2 Lustr: 167 Series 2 Daylight HD: 248 Series 2 Tungsten HD: 208
Current draw	Series 2 Lustr: 1.44 A at 120 V 0.78 A at 240 V Series 2 Daylight HD: 1.75 A at 120 V 0.93 A at 240 V Series 2 Tungsten HD: 2.08 A at 120 V 0.93 A at 240 V

*All measurements are for 120 V, 60 Hz. Results may vary in different regions.

Thermal

Ambient operating temp	0°–40°C (32°–104°F)
Fan (controllable)	Yes (yes)
Droop compensation	Yes
dB range	22.5 dBA average at 1 m
BTUs/hour	Series 2 Lustr: 569 Series 2 Daylight HD: 846 Series 2 Tungsten HD: 709

Physical

Materials	Die-cast, all metal housing
Color options	Black, white, silver, or custom color
Mounting options	Yoke, cyc floor stand (sold separately)
IP rating	IP20
Weight	With barrel: 8.3 kg (18.3 lb) Without barrel: 6.5 kg (14.3 lb)
Included accessories	Hanging yoke, 1.5 m power cable, soft-focus diffuser in an A-size gobo holder, gel frame
Notes	- Positive locking double-clutch fixture body - Slot for glass or stainless steel patterns and soft focus diffuser - Wide accessory slot with sliding cover for motorized pattern device or iris

Warranty

Fixture	5 years
LED array	10 years

Regulatory and Compliance

Approved regulatory standards	cETLus Listed Conforms to UL1573 Certified to C22.2 C22.#166 CE Compliant
-------------------------------	--

PRODUCT FEATURES

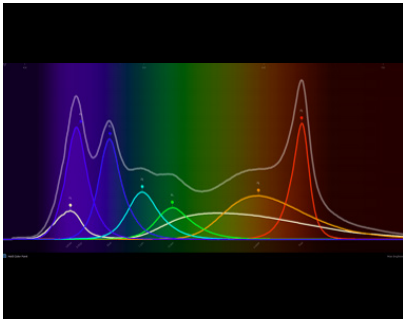

BROAD SPECTRUM COLOR
 Interacts seamlessly with conventional sources. Beautifully illuminates skin tones and other objects for natural appearance and high color rendering.



USER-FRIENDLY CONTROL INTERFACE
 With multiple modes and fixture settings including color mixing as 'hue, saturation, brightness' or 'RGB.'

COLOR METRIC INFORMATION

SOURCE FOUR LED SERIES 2 LUSTR 3200 K TM-30-18

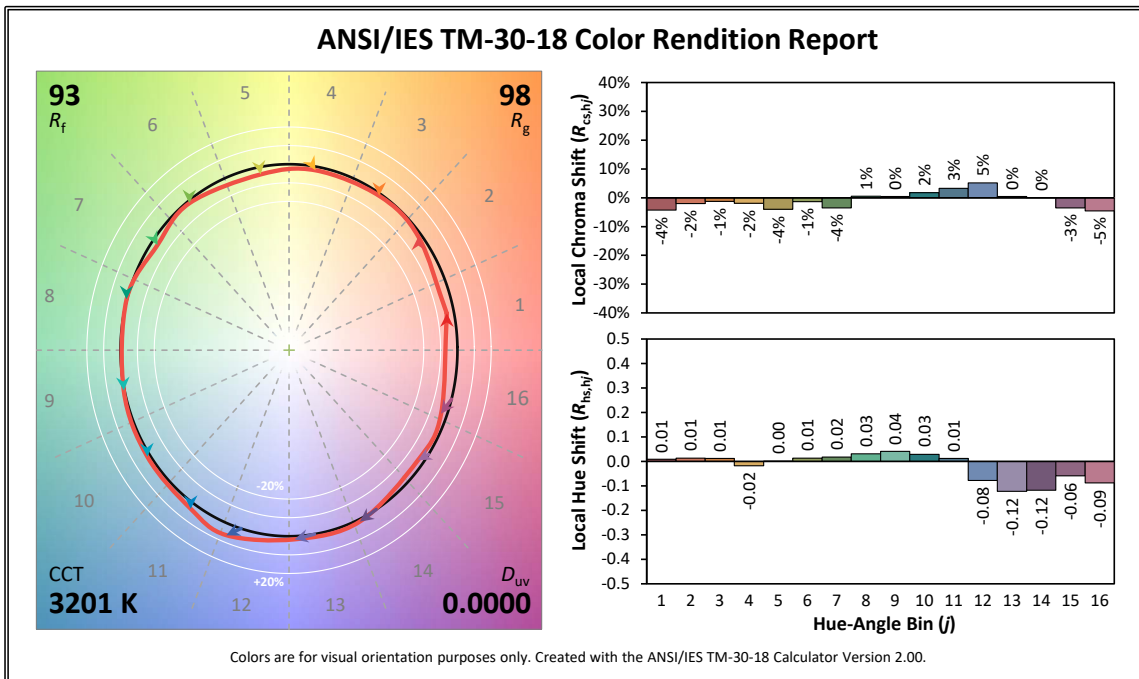

COLOR METRIC INFORMATION

SOURCE FOUR LED SERIES 2 LUSTR 4500 K TM-30-18

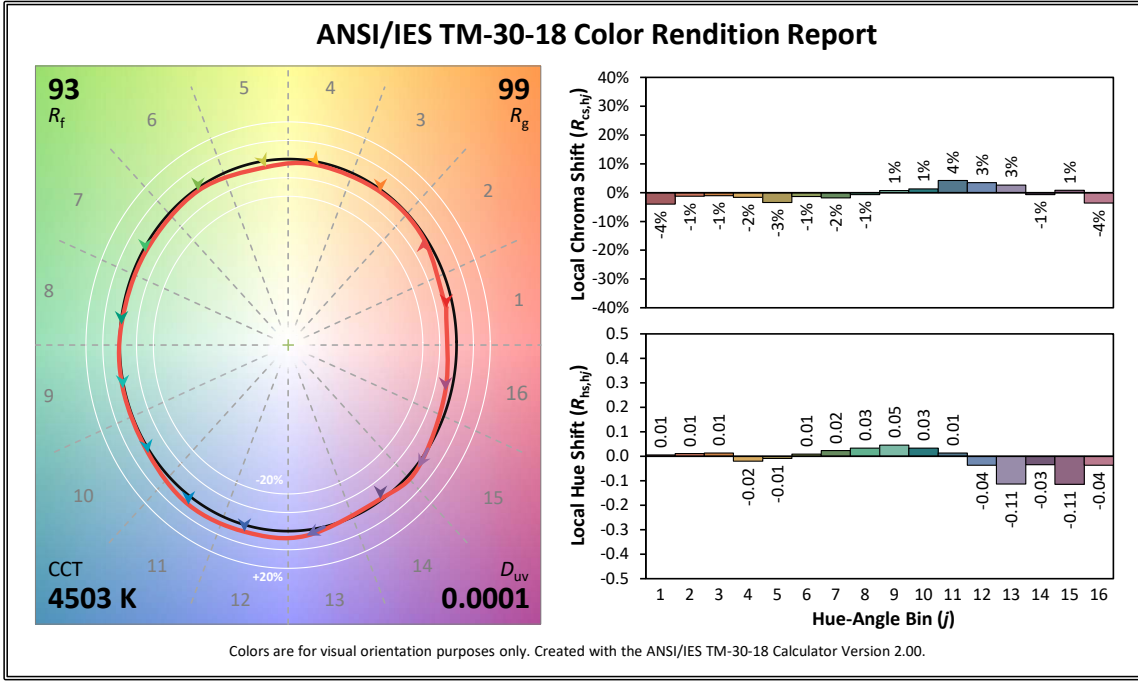

SOURCE FOUR LED SERIES 2 LUSTR 5600 K TM-30-18

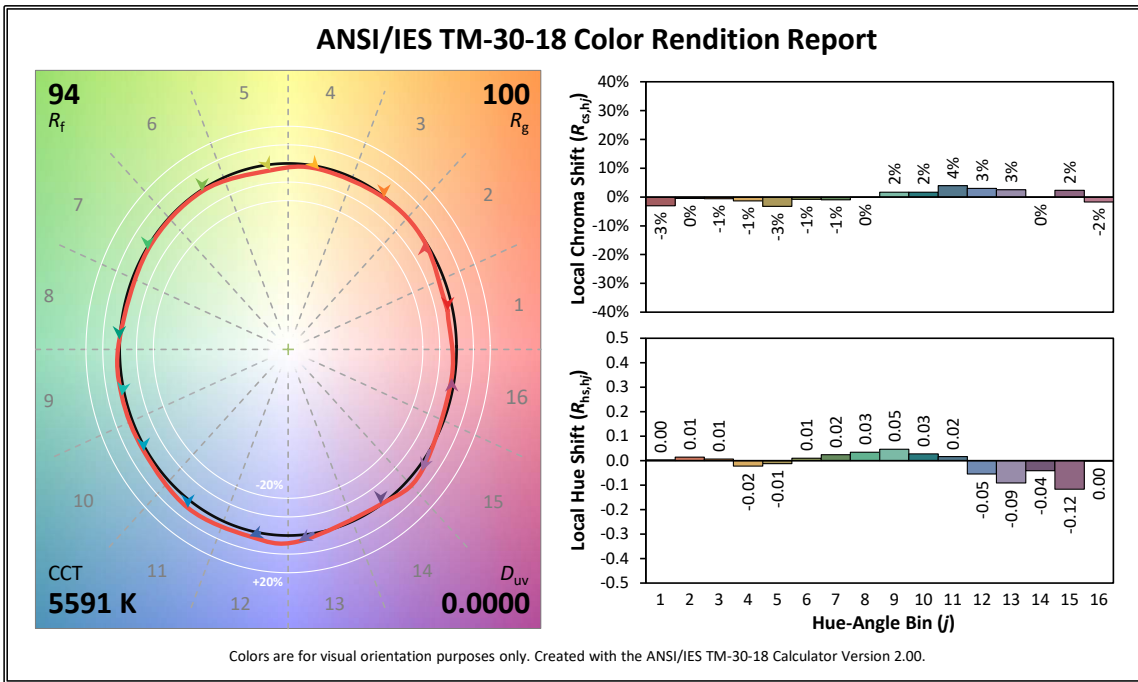

COLOR METRIC INFORMATION

SOURCE FOUR LED SERIES 2 DAYLIGHT 3200 K TM-30-18

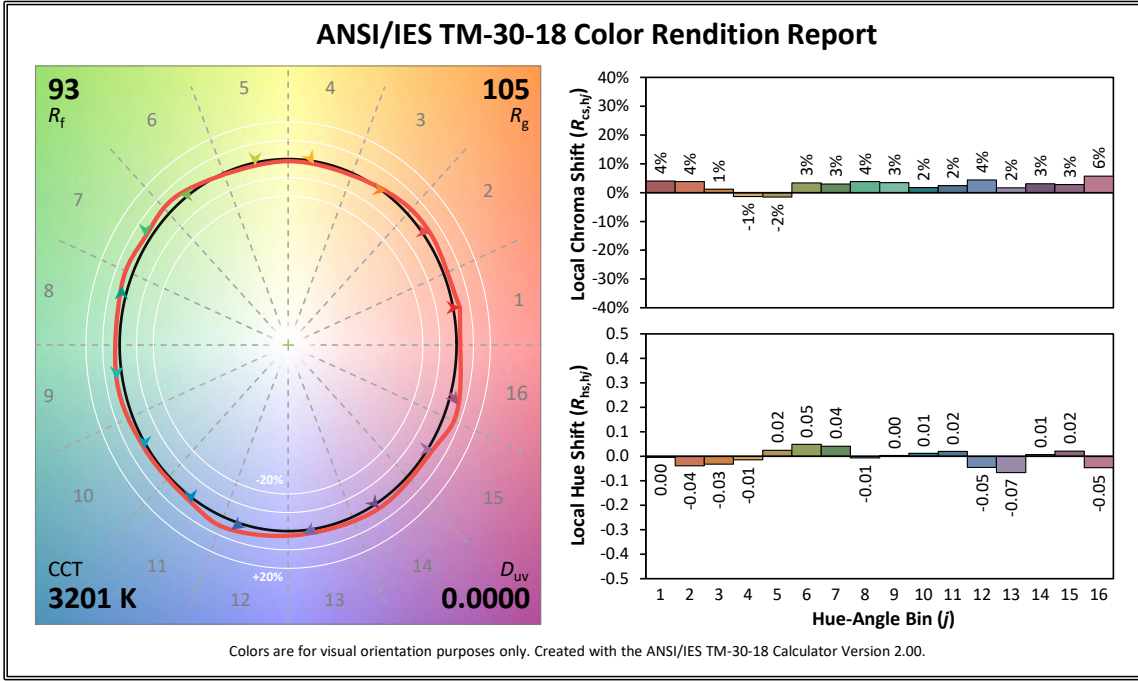

SOURCE FOUR LED SERIES 2 DAYLIGHT 4500 K TM-30-18

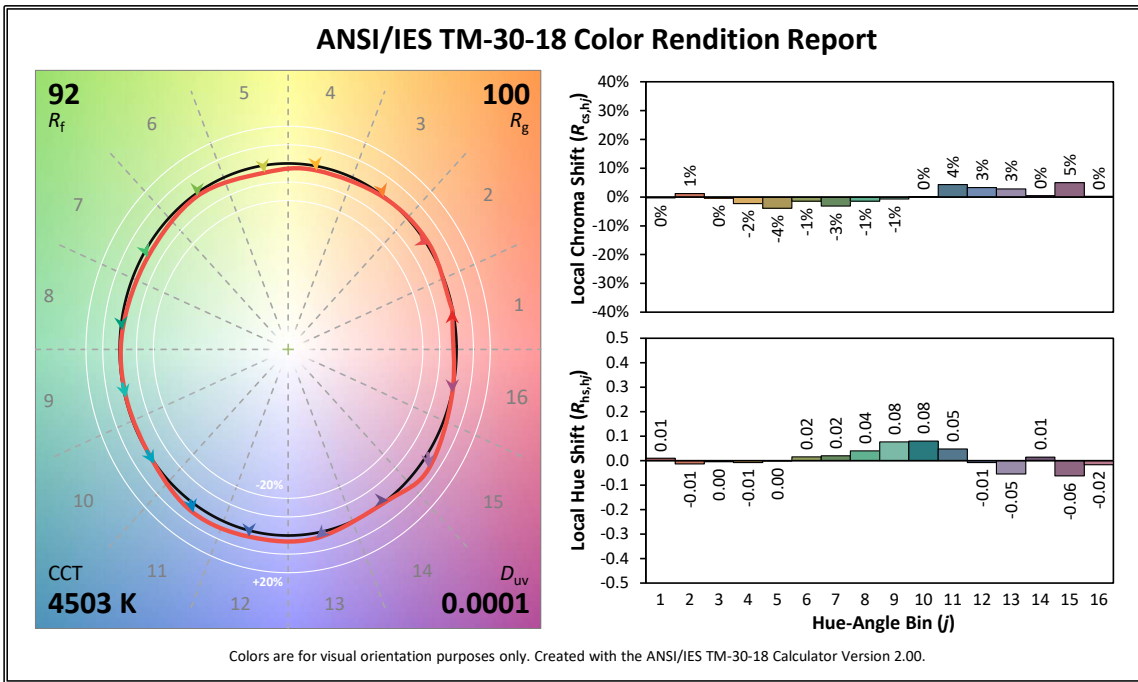

COLOR METRIC INFORMATION

SOURCE FOUR LED SERIES 2 DAYLIGHT 5600 K TM-30-18

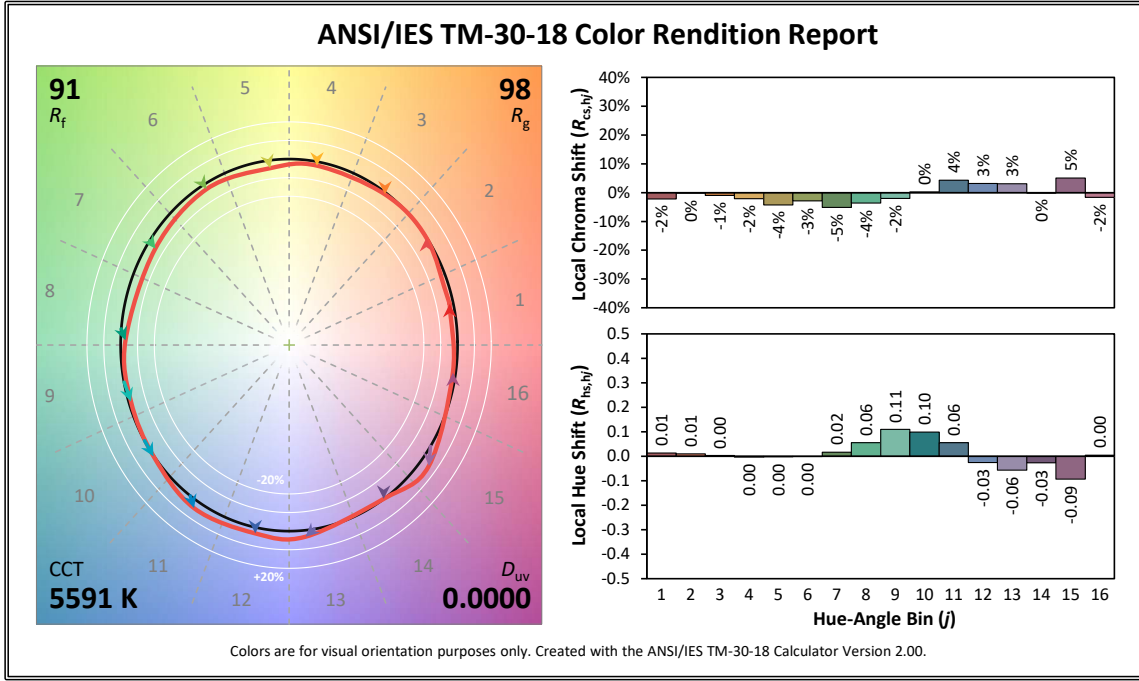

SOURCE FOUR LED SERIES 2 TUNGSTEN 3200 K TM-30-18

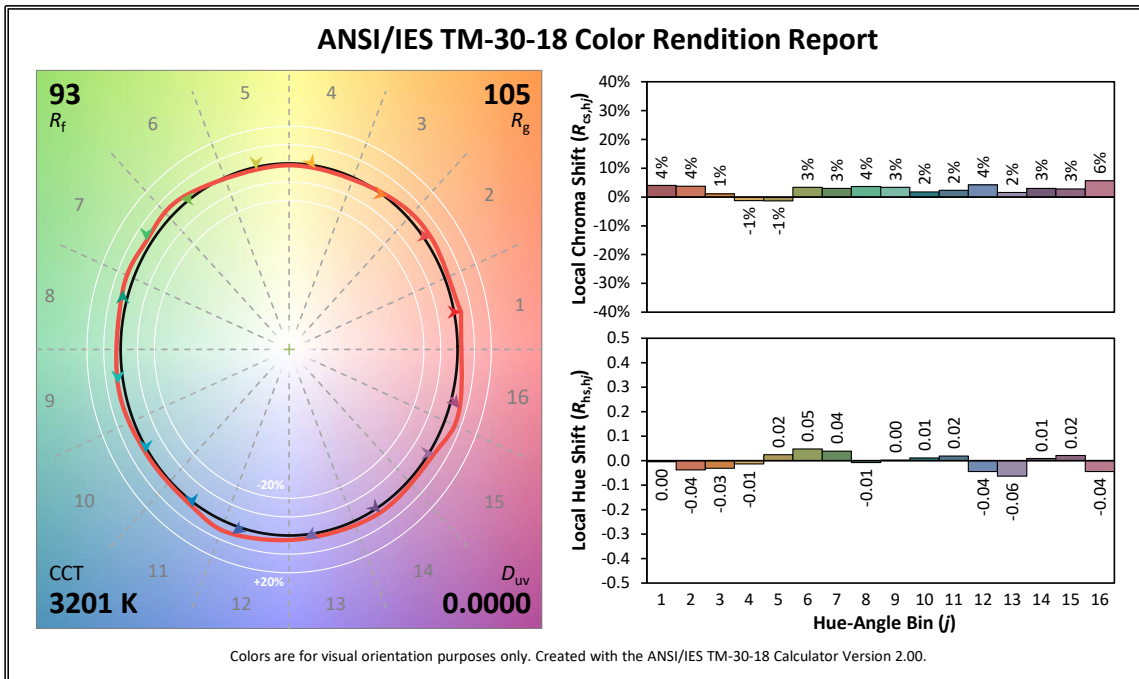

COLOR METRIC INFORMATION

SOURCE FOUR LED SERIES 2 TUNGSTEN 4500 K TM-30-18

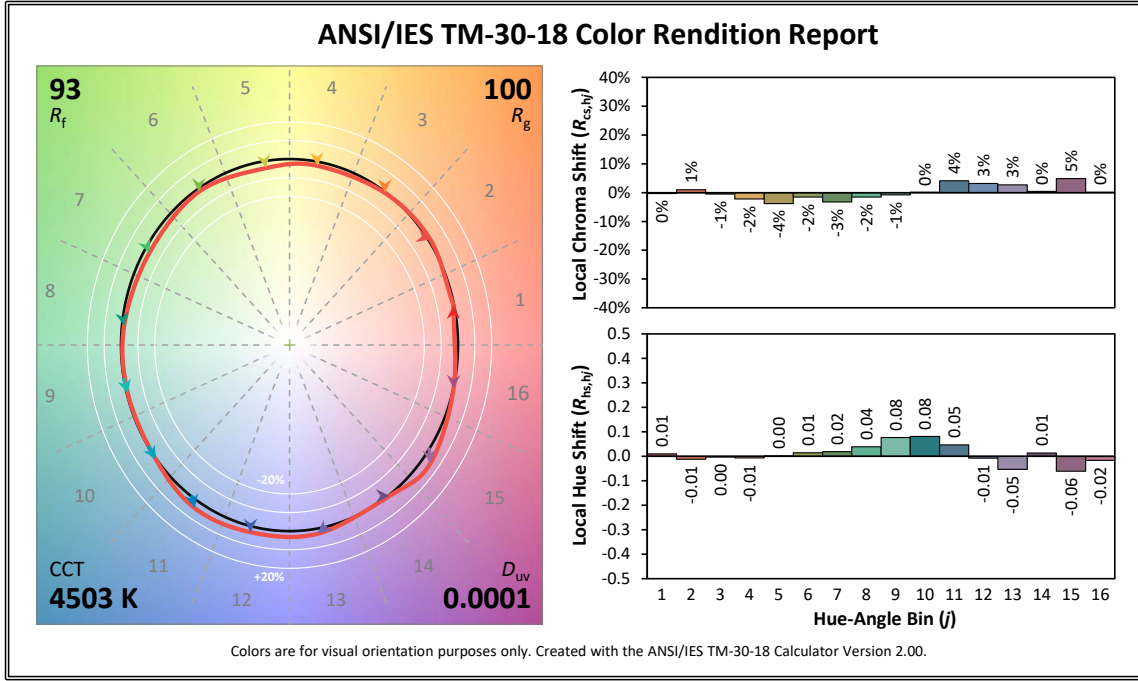

SOURCE FOUR LED SERIES 2 TUNGSTEN 5600 K TM-30-18

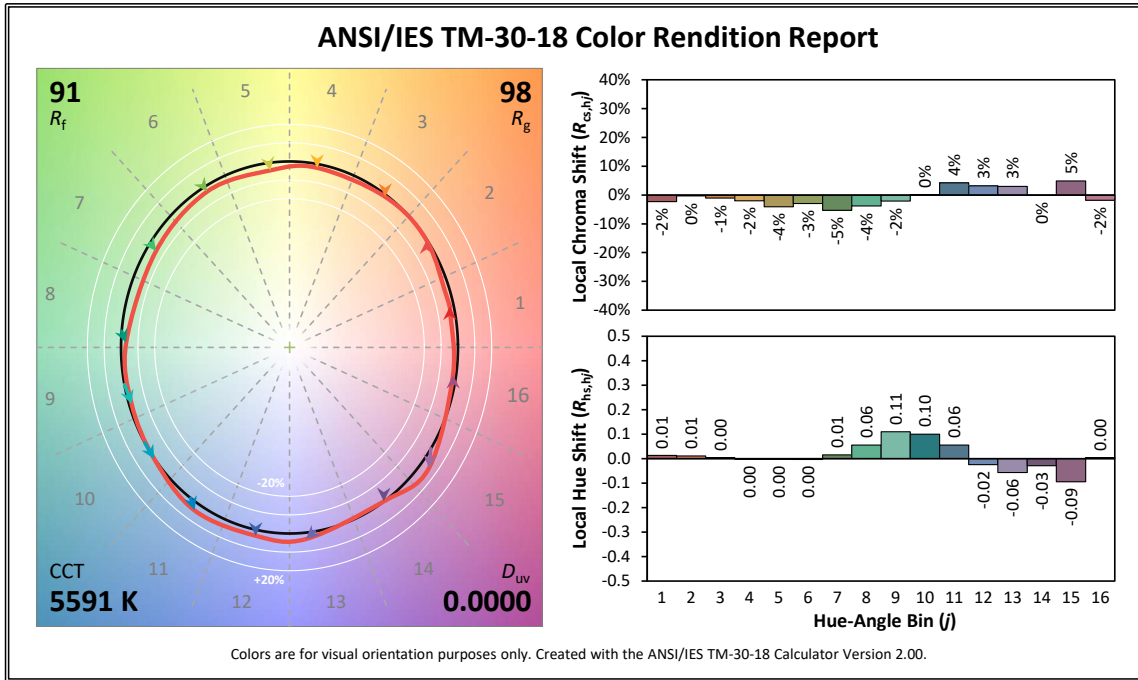

FIXTURE COMPARISON - DAYLIGHT HD AND TUNGSTEN HD

The data below was measured on a Source Four LED Series 2 Daylight HD and Tungsten HD against a Source Four LED Series 1 Studio HD, Studio Daylight and Studio Tungsten. All in Regulated mode.

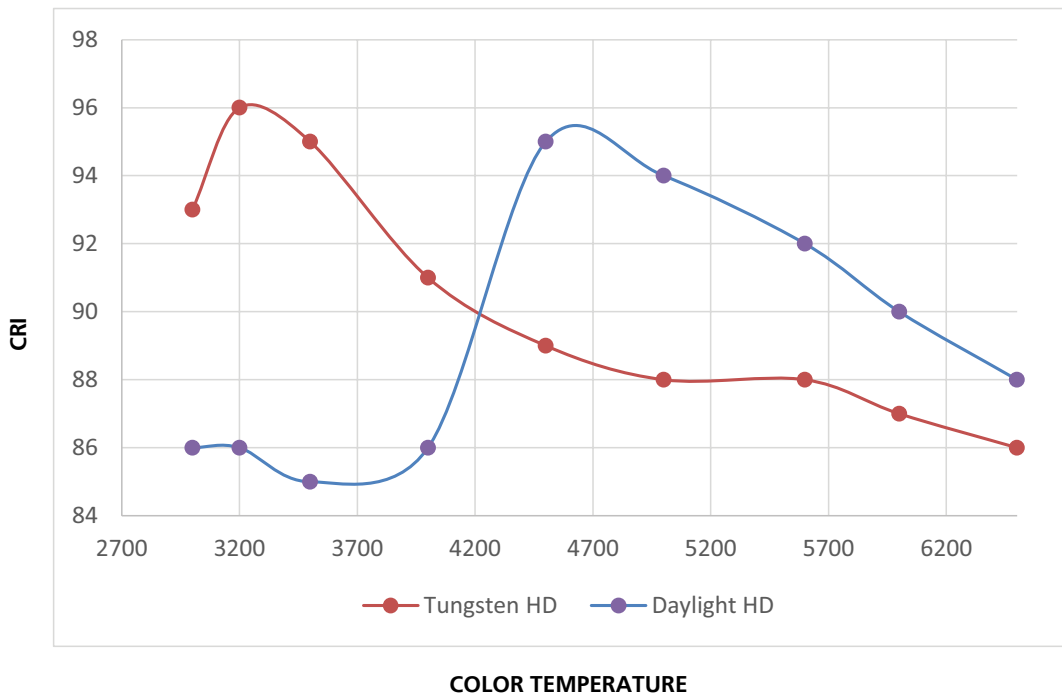
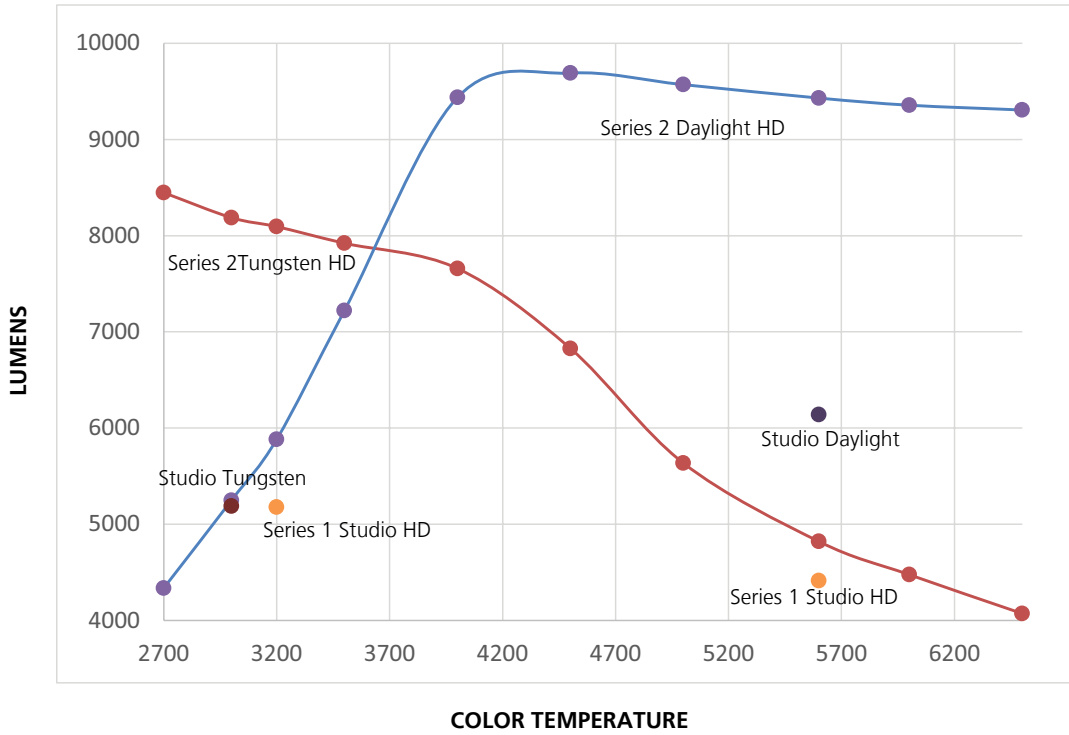

PREFERRED LENSING OPTIONS

(Lenses sold separately)

Fixed Beam Lenses

MODEL	DESCRIPTION	PART NUMBER
LED50LT	LED-specific 50° EDLT with lenses installed	7460A2008
LED50LT-1	LED-specific 50° EDLT (white) with lenses installed	7460A2008-1
436EDLT	36° EDLT w/lens installed	7060A2048
436EDLT-1	36° EDLT (white) w/lens installed	7060A2048-1
426EDLT	26° EDLT w/lens installed	7060A2047
426EDLT-1	26° EDLT (white) w/lens installed	7060A2047-1
419EDLT	19° EDLT w/lens installed	7060A2046
419EDLT-1	19° EDLT (white) w/lens installed	7060A2046-1
490LT	90° w/lens installed	7060A2052-K
490LT-1	90° (white) w/lens installed	7060A2052-1K
470LT	70° w/lens installed	7060A2051-K
470LT-1	70° (white) w/lens installed	7060A2051-1K
414LT	14° w/lens installed	7060A2050-K
414LT-1	14° (white) w/lens installed	7060A2050-1K
410LT	10° w/lens installed	7060A2001-K
410LT-1	10° (white) w/lens installed	7060A2001-1K
405LT	5° w/lens installed	7060A2000-K
405LT-1	5° (white) w/lens installed	7060A2000-1K

Zoom Lens Assemblies

Use with light-engine body models.

MODEL	DESCRIPTION	PART NUMBER
41530LT	Source Four 15–30° Zoom lens assembly	7060A2030-K
42550LT	Source Four 25–50° Zoom lens assembly	7060A2032-K

LED Adapters

MODEL	DESCRIPTION	PART NUMBER
S4LEDCYC	LED Cyc adapter	7460A2011
S4LEDFRES	LED Fresnel adapter	7460A2016

CRI AND CQS RATINGS

Source Four LED fixtures were evaluated for CRI and CQS performance using measured output spectrum and optimized mix solutions for a best spectral match to black body sources at 3200 K and 5600 K.

FIXTURE	CRI	CQS	COLOR FIDELITY	DUV
Source Four LED Series 2 Lustr Reg at 3200 K	86	88	88	0
Source Four LED Series 2 Lustr Reg at 5600 K	90	91	91	0
Source Four LED Series 2 Tungsten HD Reg at 3200 K	94	91	91	0.002
Source Four LED Series 2 Daylight HD Reg at 5600 K	91	89	88	0.002

All Source Four LED luminaire versions provide excellent color rendering to the eye, particularly at higher color temperature settings, such as 5600 K. In most cases, the Duv is 0.000. A Duv rating of 0.000 indicates that the color mix used is exactly on the black body line, with no green or magenta tint.

ADDITIONAL ORDERING INFORMATION

Fixture Accessories

MODEL	DESCRIPTION	PART NUMBERS
400CC	C-clamp	7060A2009 (not CE)
400SC	Safety cable	7060A1022
400PH-A	Pattern holder (A size)	7060A1013
400PH-B	Pattern holder (B size)	7060A1014
400PH-G	Glass pattern holder	7060A1019
400RS	Drop-In Iris	7060A1012
400CF	Color frame (6.25 in)	7060A3043
407CF	7.5 in square color frame	7061A3007
400DN	Donut	7060A1015
400TH	Top hat, 6.35 in/159 mm	PSF1021
400PTH6	Top hat, 7.5 in/191 mm	PSF1023
410TH	Top hat, 12 in/305 mm (for 10° lens tubes)	PSF1024
405TH	Top hat, 14 in/356 mm (for 5° lens tubes)	PSF1025
400HH	Half hat	PSF10216
DPSJ-X	25 ft PowerCON to Edison input power cable with inline switch	7400B7030 (not CE)

Power Input Cables

Use information below to order 5 ft power input leads with factory-fitted connectors. CE fixtures ship with powerCON to bare end cable in the box.

MODEL	DESCRIPTION	PART NUMBERS
DPA-A	5 ft PowerCON to parallel blade U-ground (Edison) connector	7410B7037-A
DPA-B	5 ft PowerCON to 20 A two-pin and ground (stage pin) connector	7410B7037-B
DPA-C	5 ft PowerCON to grounded 20 A twistlock connector	7410B7037-C
DPA-X	5 ft PowerCON to bare-end power input lead	7410B7037-X

Power Thru Jumpers

Note: Power thru jumpers connect to fixture's output (thru) connector to provide link to successive fixtures

MODEL	DESCRIPTION	PART NUMBERS
DPJ-5	5 ft PowerCON-to-PowerCON fixture-to-fixture jumper	7410B7020
DPJ-10	10 ft PowerCON-to-PowerCON fixture-to-fixture jumper	7410B7010

Diffusers

MODEL	DESCRIPTION	PART NUMBERS
S4LED-SFD	Source Four LED - Soft focus diffuser (included)	7460A4019
S4LED-SWD6	Source Four LED - Smooth wash diffuser for 6.25 in gel frame slots	7460K1001
S4LED-SWD7	Source Four LED - Smooth wash diffuser for 7.5 in gel frame slots	7460K1002
S4LED-SWD12	Source Four LED - Smooth wash diffuser for 10° lens tubes	7460K1003
S4LED-SWD14	Source Four LED - Smooth wash diffuser for 5° lens tubes	7460K1004

The Soft Focus Diffuser fits into a standard A-Size pattern holder and delivers beautiful homogenized light when not in sharp focus. Also, use with patterns for dappled and soft-edge projections.

The Smooth Wash Diffuser is used when extra-smooth blending of multiple Source Four LED fixtures is required. The smooth wash diffuser is placed into the gel-frame slot of the lens tube.

CONTROL OPTIONS

User settings on Source Four LED Series 2 fixtures allow multiple operational modes and settings for either console operation via DMX protocol or stand-alone operation. The expanded LCD display provides easy navigation to all possible settings and options. Some of the setting options are:

- Multiple DMX choices ranging from a simple RGB profile – which effectively controls all seven LED colors via three channels – to nine-channel ‘direct’ color and intensity control
- Multiple dimming curve options
- Preset colors and sequences for stand-alone (no console required) operation
- White point selection: white light and color behavior based on a specific color-temperature white light, i.e. 3200 K, 5600 K, etc.
- Loss of data behavior options – instant off, hold last look for two minutes, etc.
- Output modes – three output options that offer you a choice between maximum output and maximum consistency

See the user manual for a complete explanation of all of the control settings and options for the Source Four LED Series 2.

To assist in managing the numerous control and fixture behavior choices, five combinations of operational settings are available to quickly get started. These settings are specifically created for different applications and are easily accessible at the fixture display. Each setting can then be modified as required to take advantage of all of the possible control features.

Setting Title	Profile	Description	Typical Features*
General	Direct	Factory Default: For general-purpose use, including interior architectural applications	<ul style="list-style-type: none"> • Standard dimming curve • Regulated output for color consistency
Stage	HSI Plus 7 Enabled	Theatrical lighting: Duplicates the color and dimming behavior of tungsten stage lighting fixtures	<ul style="list-style-type: none"> • Incandescent dimming curve • Regulated output for color consistency • 3200 K white-point setting
XT Arch	HSI	Exterior architectural lighting: Provides a high degree of color consistency in high ambient temperature environments	<ul style="list-style-type: none"> • Standard dimming curve • Protected output • 3200 K white-point setting
High Impact	RGB	Event lighting: Enables quickest response, simple RGB control and strobe channel for maximum effect usage	<ul style="list-style-type: none"> • Quick dimming curve • Boost mode for maximum intensity • 5600 K white-point setting
Studio	Studio	Studio factory default: Enables three-parameter control of white light (intensity, white point, and tint) via DMX from console or console-free from fixture display	<ul style="list-style-type: none"> • Linear dimming curve • Regulated output mode for color consistency

*See user manual for complete list of features for each Quick Setup

LUSTER CONTROL OPTIONS

DMX Input Channel Profiles

DMX Profile	DMX Channels	Channel Assignments	Notes
Direct	10	1 – Red 2 – Lime 3 – Amber 4 – Green 5 – Cyan 6 – Blue 7 – Indigo 8 – Intensity 9 – Strobe 10 – Fan Control	Direct control of each individual color with a separate master- intensity channel. Color calibration of LEDs is not active in this mode. This profile will produce additive color crossfades.
HSI	6	1 – Hue (coarse) 2 – Hue (fine) 3 – Saturation 4 – Intensity 5 – Strobe 6 – Fan Control	High-resolution hue (two channels), saturation, and intensity control. HSI mode will produce color crossfades around the color space.
HSIC	7	1 – Hue (coarse) 2 – Hue (fine) 3 – Saturation 4 – Intensity 5 – Strobe 6 – Fan Control 7 – Color Point (CCT)	High-resolution hue, saturation and intensity control as above, with the addition of a color- point channel to adjust the color temperature of the fixture in both white light and color. Color crossfade performance is the same as HSI.
RGB	6 (Ch. 4 not used)	1 – Red 2 – Green 3 – Blue 4 – n/a 5 – Strobe 6 – Fan Control	Effectively addresses all seven colors via three channels of control. RGB profile will produce additive color crossfades.
Studio	6 (Ch. 4 not used)	1 – Intensity 2 – Color Point (CCT) 3 – Tint 4 – n/a 5 – Strobe 6 – Fan Control	Controls fixture as a white light unit. If no DMX, (console input, for example), is present, the fixture can be adjusted for these three parameters on the user interface at the back of the unit.

ADDITIONAL PROFILE OPTIONS

Plus 7	Seven additional color-control channels are available in RGB, HSI and HSIC input-profile settings. For example, HSI with ‘Plus 7’ enabled becomes a 15-channel profile:	
	1 – Hue (coarse) 2 – Hue (fine) 3 – Saturation 4 – Intensity 5 – Strobe 6 – Fan Control 7 – n/a 8 – Plus 7 Control on/off 9 – Red 10 – Lime 11 – Amber 12 – Green 13 – Cyan 14 – Blue 15 – Indigo	The desired color and intensity is achieved by using the HSI or RGB channels Placing channel eight at a value over 51% gives the fixture a 15-channel profile Channels 9–15 represent the native colors of the fixture and allow the operator to adjust individual color channels to fine tune the color output
Strobe	Variable strobe control: 0% is no strobe. The fixture output will strobe more rapidly as the strobe channel value approaches 100%.	

DAYLIGHT HD CONTROL OPTIONS

DMX Input Channel Profiles

DMX Profile	DMX Channels	Channel Assignments	Notes
Studio	6 (Ch. 4 not used)	1 – Intensity 2 – Color Point (CCT) 3 – Tint 4 – n/a 5 – Strobe 6 – Fan Control	Controls fixture as a white light unit. If no DMX, (console input, for example), is present, the fixture can be adjusted for these three parameters on the user interface at the back of the unit.
Direct	10	1 – Red 2 – Mint 3 – Blue 4 – Indigo 5 – Intensity 6 – Strobe 7 – Fan Control	Direct control of each individual color with a separate master- intensity channel. Color calibration of LEDs is not active in this mode. This profile will produce additive color crossfades.
HSI	6	1 – Hue (coarse) 2 – Hue (fine) 3 – Saturation 4 – Intensity 5 – Strobe 6 – Fan Control	High-resolution hue (two channels), saturation, and intensity control. HSI mode will produce color crossfades around the color space.
HSIC	7	1 – Hue (coarse) 2 – Hue (fine) 3 – Saturation 4 – Intensity 5 – Strobe 6 – Fan Control 7 – Color Point (CCT)	High-resolution hue, saturation and intensity control as above, with the addition of a color- point channel to adjust the color temperature of the fixture in both white light and color. Color crossfade performance is the same as HSI.
RGB	6 (Ch. 4 not used)	1 – Red 2 – Green 3 – Blue 4 – n/a 5 – Strobe 6 – Fan Control	Effectively addresses all seven colors via three channels of control. RGB profile will produce additive color crossfades.

ADDITIONAL PROFILE OPTIONS

Plus 7	Seven additional color-control channels are available in RGB, HSI and HSIC input-profile settings. For example, HSI with 'Plus 7' enabled becomes a 15-channel profile:	
	1 – Intensity 2 – Color Temp 3 – Tint 4 – NA 5 – Strobe 6 – Fan 7 – NA 8 – Plus 7 Control on/off 9 – Red 10 – NA 11 – Mint 12 – Blue 13 – Indigo 14 – NA 15 – NA	The desired color and intensity is achieved by using the HSI or RGB channels Placing channel seven at a value over 51% gives the fixture a 15-channel profile Channels 9–15 represent the native colors of the fixture and allow the operator to adjust individual color channels to fine tune the color output
Strobe	Variable strobe control: 0% is no strobe. The fixture output will strobe more rapidly as the strobe channel value approaches 100%.	

TUNGSTEN HD CONTROL OPTIONS

DMX Input Channel Profiles

DMX Profile	DMX Channels	Channel Assignments	Notes
Studio	6 (Ch. 4 not used)	1 – Intensity 2 – Color Point (CCT) 3 – Tint 4 – n/a 5 – Strobe 6 – Fan Control	Controls fixture as a white light unit. If no DMX, (console input, for example), is present, the fixture can be adjusted for these three parameters on the user interface at the back of the unit.
Direct	10	1 – Red 2 – Red Orange 3 – Mint 4 – Blue 5 – Indigo 6 – Intensity 7 – Strobe 8 – Fan Control	Direct control of each individual color with a separate master- intensity channel. Color calibration of LEDs is not active in this mode. This profile will produce additive color crossfades.
HSI	6	1 – Hue (coarse) 2 – Hue (fine) 3 – Saturation 4 – Intensity 5 – Strobe 6 – Fan Control	High-resolution hue (two channels), saturation, and intensity control. HSI mode will produce color crossfades around the color space.
HSIC	7	1 – Hue (coarse) 2 – Hue (fine) 3 – Saturation 4 – Intensity 5 – Strobe 6 – Fan Control 7 – Color Point (CCT)	High-resolution hue, saturation and intensity control as above, with the addition of a color- point channel to adjust the color temperature of the fixture in both white light and color. Color crossfade performance is the same as HSI.
RGB	6 (Ch. 4 not used)	1 – Red 2 – Green 3 – Blue 4 – n/a 5 – Strobe 6 – Fan Control	Effectively addresses all seven colors via three channels of control. RGB profile will produce additive color crossfades.

ADDITIONAL PROFILE OPTIONS

Plus 7	Seven additional color-control channels are available in RGB, HSI and HSIC input-profile settings. For example, HSI with 'Plus 7' enabled becomes a 15-channel profile:	
	1 – Intensity 2 – Color Temp 3 – Tint 4 – NA 5 – Strobe 6 – Fan 7 – NA 8 – Plus 7 Control on/off 9 – Red 10 – Orange 11 – Mint 12 – Blue 13 – Indigo 14 – NA 15 – NA	The desired color and intensity is achieved by using the HSI or RGB channels Placing channel seven at a value over 51% gives the fixture a 15-channel profile Channels 9–15 represent the native colors of the fixture and allow the operator to adjust individual color channels to fine tune the color output
Strobe	Variable strobe control: 0% is no strobe. The fixture output will strobe more rapidly as the strobe channel value approaches 100%.	

PHOTOMETRY

The Source Four LED Photometry Guide and complete IES photometry data files may be downloaded from the ETC website. Go to etconnect.com.

PHYSICAL

	WEIGHT		SHIPPING WEIGHT	
	lb	kg	lb	kg
With Barrel	18.3	8.3	28	12.7
Without Barrel	14.3	6.5	23	10.4

*Does not include mounting hardware or lens tube

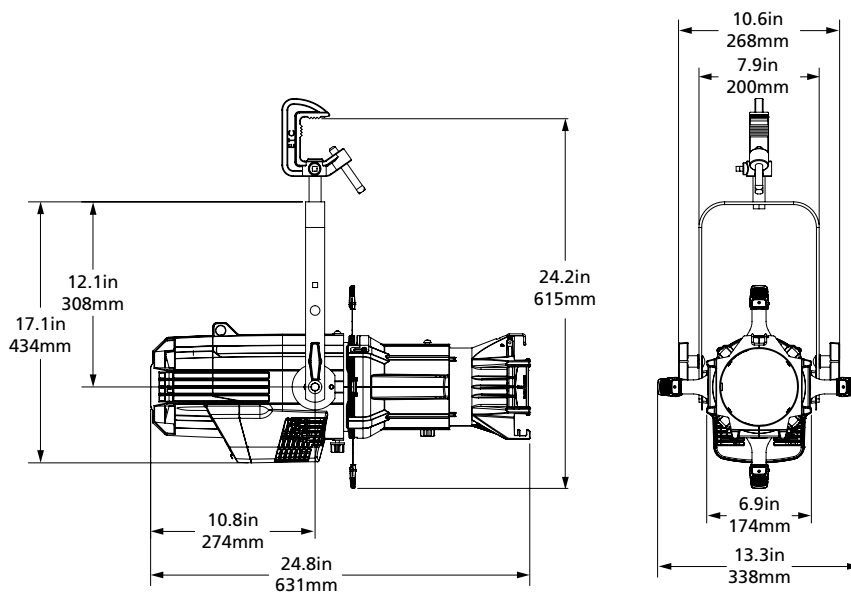

Corporate Headquarters • Middleton, WI USA
Global Offices • London, UK • Rome, IT • Holzkirchen, DE • Paris, FR • Hong Kong
 Dubai, UAE • Singapore • New York, NY • Orlando, FL • Los Angeles, CA • Austin, TX
 ©2024 ETC. All Rights Reserved. All product information and specifications subject to change. Rev Q 2024-03
 *Trademark and patent info: etconnect.com/IP • Third-party license agreement info: etconnect.com/licenses

etconnect.com