

# Linea Research 44M/48M Series Advanced System Amplifier User Guide

Version 8 (For firmware version 1.478 and above)



# Contents

---

COMPLIANCE .....	7
FOR CUSTOMERS IN EUROPE .....	7
FOR CUSTOMERS IN THE USA.....	8
FOR CUSTOMERS IN CANADA.....	8
Thanks and Unpacking.....	9
Unpacking the Linea Research 44/48 Series Amplifier.....	9
INSTALLATION INSTRUCTIONS .....	10
Mechanical Installation .....	10
AC Power Connection .....	11
The User Guide .....	12
Introduction and Key Features .....	13
Introduction.....	13
Key Features .....	13
Audio Connections.....	16
Input Connections .....	16
Using unbalanced connections.....	16
Amplifier Output Connections.....	17
Load Matching .....	18
Panel Layouts.....	19
Operation.....	21
Starting up the unit.....	21
Overview of Modules, Presets Components and Snapshots.....	21
Navigation.....	22
The Home Page.....	23
Drive Modules .....	23
Drive Module Presets .....	23
Component Presets .....	23
Factory Module Presets.....	24
Storing Module Presets .....	24
Recalling Module Presets .....	24
Recalling Components .....	25
Input .....	25
AES3 Inputs.....	25
Networked Audio (Dante) Inputs .....	25

Automatic Input Selection (Failover).....	26
Gain and Polarity .....	26
Delay .....	26
High Pass Filter .....	26
Parametric Equalisation.....	26
FIR Shelving EQ.....	26
Parametric Filters .....	27
Routing.....	27
Output .....	27
Gain and Polarity .....	27
Delay .....	27
High and Low pass Filters .....	27
LIR Crossover Filtering .....	28
Parametric Equalisation and All-Pass Filters .....	28
FIR Filter (available on some models).....	28
Limiters .....	28
Bridge.....	30
Routing.....	30
Dante Outputs .....	30
Utility Pages .....	31
Screen Contrast .....	31
Stereo Linking .....	31
Version.....	31
Dante Name.....	31
Current Ethernet IP Address.....	31
IP Mode.....	31
IP Static .....	31
Store Snapshot.....	31
Recall Snapshot.....	31
Bandwidth Units .....	32
Aux Style .....	32
ECO .....	32
External Breaker Protection (EBP).....	32
Ethernet.....	32
Ethernet configurations.....	32

DHCP .....	32
AUTO-IP .....	33
Static-IP .....	33
IP Troubleshooting.....	33
Snapshots .....	33
AUX Port .....	34
Latency delay .....	35
Input/Output Latencies .....	35
Processing Latencies.....	35
Secure Mode.....	36
Overlay Flush .....	36
Revert to Factory Settings .....	36
Protection Systems.....	36
Summary of Protection Indication .....	37
Incident Reporting.....	37
Fault Relay .....	37
Performance Logging.....	38
Tipi Third Party Interface.....	38
Processing Block Diagram.....	39
Output Menu Map.....	41
EQ and Filter Response Graphs .....	42
Technical Specifications.....	45
General .....	45
Audio.....	45
Digital processing.....	45
Power Output .....	46
Power supply .....	46
Protection systems .....	46
System protection .....	47
Power distribution protection systems .....	47
Monitoring and logging .....	47
OEM Features .....	47
Physical .....	47
Options .....	48

## IMPORTANT SAFETY INSTRUCTIONS



The lightning bolt triangle is used to alert the user to the risk of electric shock.



The exclamation point triangle is used to alert the user to important operating or maintenance instructions.

- 1 Read these instructions.
- 2 Keep these instructions.
- 3 Heed all warnings.
- 4 Follow all instructions.
- 5 Do not use this apparatus near water.
- 6 Clean only with dry cloth.
- 7 Do not block any ventilation openings. Install in accordance with the manufacturer's instructions.
- 8 Do not install near any heat sources such as radiators, heat registers, stoves or other apparatus (including amplifiers) that produce heat.
- 9 Do not defeat the safety purpose of the polarized or grounding type plug. A polarized plug has two blades with one wider than the other. A grounding type plug has two blades and a third grounding prong. The wide blade or the third prong are provided for your safety. If the provided plug does not fit into your outlet, consult an electrician for replacement of the obsolete outlet.
- 10 Protect the power cord from being walked on or pinched particularly at plugs, convenience receptacles and the point where they exit from the apparatus.
- 11 Only use attachments / accessories specified by the manufacturer.
- 12 Use only with the cart, tripod, bracket or table specified by the manufacturer, or sold with the apparatus. When a cart is used, use caution when moving the cart / apparatus combination to avoid injury from tip-over.
- 13 Unplug this apparatus during lightning storms or when unused for long periods of time.
- 14 Refer all servicing to qualified service personnel. Service is required when the apparatus has been damaged in any way, such as power-supply cord or plug damaged, liquid has been spilled or objects have fallen into the apparatus, this apparatus has been exposed to rain or moisture, does not operate normally, or has been dropped.
- 15 The apparatus shall not be exposed to dripping or splashing and no objects filled with liquids, such as vases, shall be placed on the apparatus.
- 16 Permanent disconnection from the mains supply is to be achieved by removing the supplied cord connector from the back of the unit. This connector must remain readily operable.



### **WARNING**

Do not remove any covers, loosen any fixings or allow items to enter any aperture.



### **WARNING**

This product must be earthed. Use only a flexible cable or cord with a green and yellow core which must be connected to the protective earthing terminal of a suitable mains plug or the earthing terminal of the installation



### **WARNING**

The rear of the product may get hot. Avoid direct skin contact during operation and for at least 5 minutes after power has been isolated.



### **WARNING**

This product is designed for permanent installation. It must be fitted in to a 19" rack enclosure and not operated unless so installed. The rack enclosure must allow free air movement through the product.

## CONSIGNES DE SÉCURITÉ IMPORTANTES

---



Le triangle de l'éclair est utilisé pour alerter l'utilisateur  
À risque d'électrocution.



Le triangle du point d'exclamation est utilisé pour alerter l'utilisateur sur des importants  
Instructions d'utilisation ou d'entretien.

1. Lisez ces instructions.
2. Conservez ces instructions.
3. Respectez tous les avertissements.
4. Suivez toutes les instructions.
5. Ne pas utiliser cet appareil près de l'eau.
6. Nettoyer uniquement avec un chiffon sec.
7. Ne pas bloquer les ouvertures de ventilation. Installer conformément aux instructions du fabricant.
8. Ne pas installer près de sources de chaleur telles que radiateurs, registres de chaleur, poêles ou autres appareils (y compris les amplificateurs) qui produisent de la chaleur.
9. Ne supprimez pas le dispositif de sécurité de la fiche polarisée ou mise à la terre. Une fiche polarisée possède deux lames dont l'une est plus large que l'autre. Une prise de terre a eu deux lames et une troisième broche de terre. La lame large ou la troisième broche sont fournies pour votre sécurité. Si la fiche fournie ne rentre pas dans votre prise, consultez un électricien pour remplacer la prise obsolète.
10. Protéger le cordon d'alimentation soit écrasé ou pincé, particulièrement au niveau des fiches, des prises et le point où ils sortent de l'appareil.
11. Utilisez uniquement les accessoires spécifiés par le fabricant.
12. Utilisez uniquement le chariot, le trépied, le support ou la table spécifiés par le fabricant, ou vendu avec l'appareil. Quand un chariot est utilisé, soyez prudent lorsque vous déplacez l'ensemble chariot / appareil afin d'éviter toute blessure en cas de chute.
13. Débranchez cet appareil pendant les orages ou lorsqu'il n'est pas utilisé pendant de longues périodes de temps.
14. Adressez-vous à un personnel qualifié. Une réparation est requise lorsque l'appareil a été endommagé de quelque façon que ce soit le cordon d'alimentation ou la fiche endommagé, du liquide a été renversé ou des objets sont tombés dans l'appareil, cet appareil a été exposé à la pluie ou à l'humidité, ne fonctionne pas normalement, ou s'il est tombé.
15. Le dispositif ne doit pas être exposé à des gouttes ou des éclaboussures et aucun objet rempli de liquides, tels que des vases, doit être placé sur l'appareil.
16. Déconnexion permanente de l'alimentation secteur doit être atteint en supprimant le connecteur du cordon fourni à l'arrière de l'unité. Ce connecteur doit être facilement utilisable.



### ATTENTION

Ne retirez pas les couvercles, ne desserrez pas les fixations et ne laissez aucune pièce s'introduire dans les ouvertures.



### ATTENTION

Ce produit doit être mis à la terre. Utilisez uniquement un câble souple avec un noyau vert ou vert / jaune qui doit être relié à la borne de terre de connecteur d'alimentation ou la borne de terre de l'installation.



### ATTENTION

Le radiateur arrière de cet appareil devient chaud. Evitez tout contact direct avec la peau pendant le fonctionnement et au moins 5 minutes après la mise hors tension de l'appareil.



### ATTENTION

Ce produit est conçu pour une installation permanente. Il doit être installé dans un boîtier rack 19 ". L'enceinte du rack doit permettre un mouvement de l'air libre à travers le produit.

## COMPLIANCE

---

### FOR CUSTOMERS IN EUROPE

This product complies with both the LVD (electrical safety) 2014/35/EU and EMC (electromagnetic compatibility) 2014/30/EU directives issued by the commission of the European Union.

Compliance with these directives is demonstrated by conformity with the following European standards:

EN60065 8th Edition	Electrical safety
EN55032-2012	EMC emissions
EN55035-2017	EMC immunity



#### ATTENTION

This equipment is compliant with Class A of CISPR 32. In a residential environment this equipment may cause radio interference in which case the user may be required to take separate measures.



**THIS PRODUCT MUST BE EARTHED.** Use only a flexible cable or cord with a green and yellow core which must be connected to the protective earthing terminal of a suitable mains plug or the earthing terminal of the installation. The cord must be a maximum of 2m long, have a 4.0mm<sup>2</sup> CSA, a 300/500V rating and comply with EN50525-2-11 / H05W-F (105°C).

## FOR CUSTOMERS IN THE USA

This product complies with UL60065 8th edition.



THIS PRODUCT MUST BE EARTHED. Use only a flexible cable or cord with a green or green / yellow core which must be connected to the protective earthing terminal of a suitable mains plug or the earthing terminal of the installation. The cord must be a maximum of 6' long, be 12AWG, 105°C have a rating SJ, SJT, SJE or 300/500V H05W-F and be marked VW-1.



### ATTENTION

FCC SUPPLIER'S DECLARATION OF CONFORMITY (SDoC) : We, Linea Research Ltd. of 1 Marquis Business Centre, Royston Road, Baldock, Hertfordshire, SG7 6XL, England, represented in the United States by Allied Professional Technologies, LLC - [www.alliedprotech.com](http://www.alliedprotech.com), declare under our sole responsibility that the M-Series and C-Series families of products comply with Part 15 of the FCC Rules. Products covered by this declaration have model numbers of the form xxMxx or xxCxx where 'x' may be any number between 1 and 9.

FCC NOTE : An example of this equipment has been tested and found to comply with the limits for a Class A digital device, pursuant to part 15 subpart B of the FCC Rules. These limits are designed to provide reasonable protection against harmful interference when the equipment is operated in a commercial environment. This equipment generates, uses, and can radiate radio frequency energy and, if not installed and used in accordance with the instruction manual, may cause harmful interference to radio communications. Operation of this equipment in a residential area is likely to cause harmful interference in which case the user will be required to correct the interference at his own expense.

FCC CAUTION: Any changes or modifications not expressly approved by the party responsible for compliance could void the user's authority to operate this equipment.

## FOR CUSTOMERS IN CANADA

This product complies with CA /CSA C22.2 No.60065-03  
Ce produit est conforme avec CA /CSA C22.2 No.60065-03

### DECLARATION OF CONFORMITY WITH CANADIAN ICES-003

This Class A digital apparatus complies with Canadian ICES-003.

Cet appareil numérique de la classe A est conforme à la norme NMB-003 du Canada.



THIS PRODUCT MUST BE EARTHED. Use only a flexible cable or cord with a green or green / yellow core which must be connected to the protective earthing terminal of a suitable mains plug or the earthing terminal of the installation. The cord must be a maximum of 6' long, be 12AWG, 105°C have a rating SJ, SJT, SJE or 300/500V H05W-F and be marked VW-1.



CE PRODUIT DOIT ÊTRE MIS À LA TERRE. Utilisez uniquement un câble souple avec un noyau vert ou vert / jaune qui doit être relié à la borne de terre de connecteur d'alimentation ou la borne de terre de l'installation. Le cordon doit être un maximum de 6' (2m) de long, 12 AWG (4.0mm<sup>2</sup> CSA), 105°C être classé SJ, SJT, SJE ou 300/500V H05W-F et être marquée VW-1



## **Thanks and Unpacking**

---

Thank you for choosing a Linea Research 44/48 Series Advanced System Amplifier for your application. Please spare a little time to study the contents of this manual, so that you obtain the best possible performance from this unit.

All Linea Research products are carefully engineered for world-class performance and reliability.

If you would like further information about this or any other Linea Research product, please contact us. We look forward to helping you in the near future.

### **Unpacking the Linea Research 44/48 Series Amplifier**

After unpacking the unit please check carefully for damage. If damage is found, please notify the carrier concerned at once. You, the consignee, must instigate any claim. Please retain all packaging in case of future re-shipment.

# INSTALLATION INSTRUCTIONS

---

## Mechanical Installation

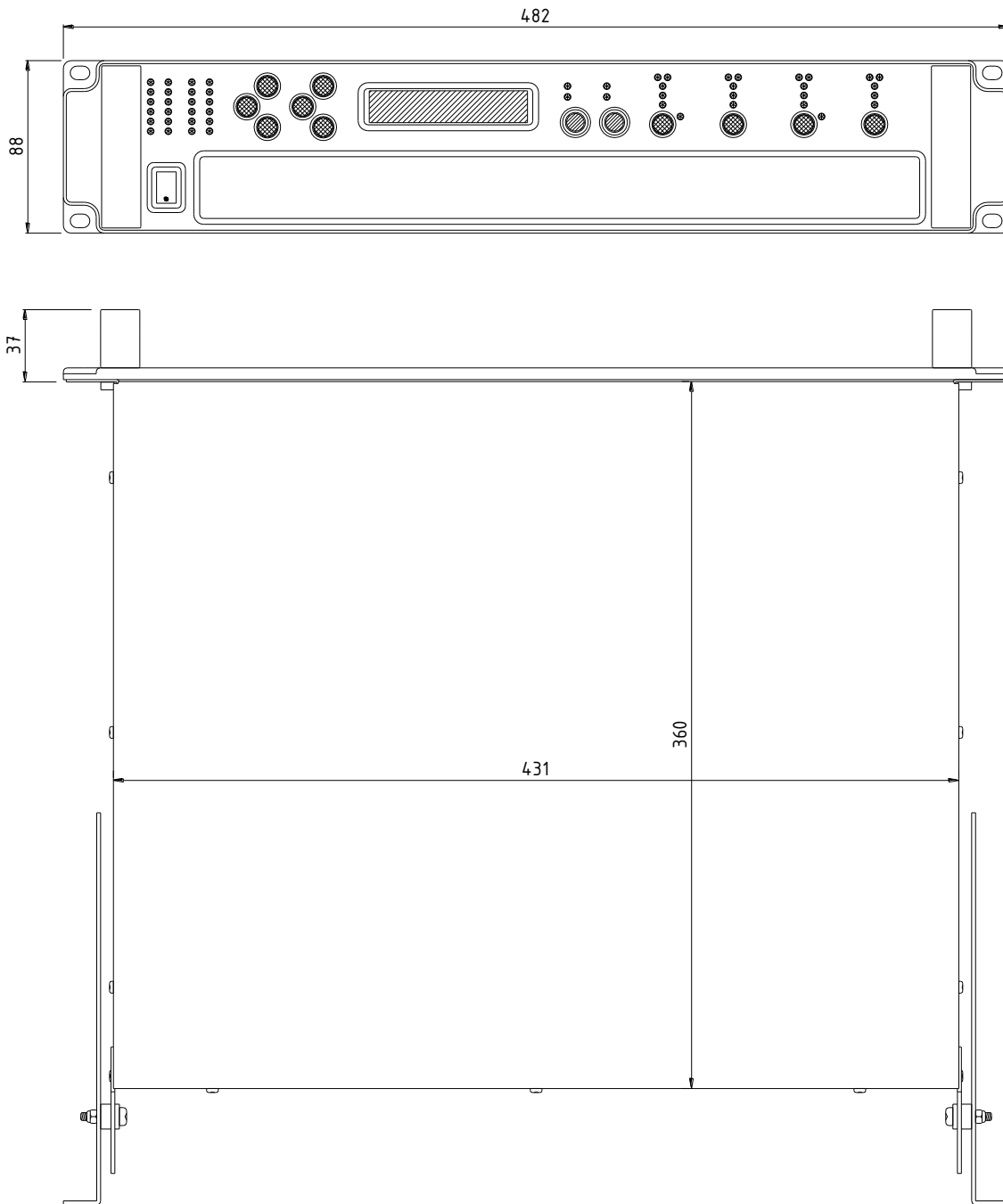

The 44/48 Series Amplifier must only be operated when mounted in a standard 19" rack enclosure.

Where the amplifier is used in a fixed installation, as long as the bottom unit is supported and there are no gaps between units, it is acceptable to use only the front panel 19" rack mounting points when fitting it in a standard rack enclosure. If the amplifier is mounted in a mobile rack it is important that the rear is supported

with a rear rack mounting kit (part number ZA1182). Damage caused by insufficient support is not covered by the manufacturer's warranty.

To prevent damage to the front panel it is recommended that plastic cups or washers are fitted underneath the rack mounting bolt heads.

It is possible to mount multiple 44/48 Series amplifiers without ventilation gaps between them but it is essential that an unobstructed flow of clean air is available from the front of the unit to the rear.



## **IMPORTANT**

### **General**

The amplifier should never be exposed to rain or moisture during operation or storage. If the unit does come into contact with moisture, remove the AC power cord immediately and leave it in a dry and warm location.

Note that when any equipment is taken from a cold location into a warm humid one, condensation may occur inside the device. Always allow time for the equipment to attain the same temperature as its surrounding environment before connecting the AC power cord.

It is the responsibility of the user to ensure that dirt, liquids and vapour from theatrical smoke and fog machines is not ingested by the amplifier. Damage so caused is not covered by the manufacturer's warranty.

### **Cooling**

It is important that neither the air intakes on the front of the unit or the exhaust vents at the rear are obstructed. Steps must also be taken to ensure that hot air does not continually circulate through the amplifiers from the back of the rack to the front.

The air intake filter must be cleaned regularly with warm water and a little detergent to ensure unrestricted airflow. The filter can be removed without the use of tools by gently pulling it out of its aperture. When refitting ensure that it is thoroughly dry and that there are no areas of the grille not covered by the filter element. Operating the amplifier without the air intake filter will invalidate the manufacturer's warranty.

### **AC Power Connection**

The amplifier utilises a 32A Neutrik PowerCon™ type locking AC power connector. Use only an AC power cord correctly terminated with a genuine Neutrik™ PowerCon™. It is the responsibility of the user to ensure that all wiring is performed by a qualified person in accordance with all local regulations.

The amplifiers are designed to operate on 115V 60Hz or 230V 50 Hz nominal AC power, automatically configuring themselves at switch on. Note that although the amplifiers will operate when the mains supply is within the range specified in this document, various specifications will only be met when the unit is operated at the stated nominal voltages.

## The User Guide

---

This user manual gives a progressively more detailed description of the functions of the Linea Research 44/48 Series Advanced System Amplifier. A single page quick reference guide is provided for those users who are experienced with this type of equipment and just need to know how to 'drive' the front panel. A detailed explanation of the front and rear panel controls and indicators is contained in the next section.

The final section describes each individual function or feature with annotated images explaining its use. Where appropriate, the graphical display is shown to further elaborate on the units operation.

To complete the manual a reference section is included, describing the technical performance of the amplifier complete with graphs of filter responses.

## Introduction and Key Features

---

### Introduction

The Linea Research 44/48 Series Advanced System Amplifier represents current state-of-the-art technology in several areas. This product is the result of several years of research, from which many advances in switched mode power technologies and ever finer detail in signal processing have stemmed. Taking advantage of the latest advances in analogue to digital conversion technologies, the unit achieves performance levels among the very best that engineering permits.

Below is a list of key features, followed by some information on the major advanced features of the product.

### Key Features

- Four/Eight channels of sonically pure Class D amplification
- Very high power density - packs four channels and 20kW or eight channels and 10kW into just 2U of rack space
- Packed with robust protection and monitoring systems to keep the show going
- External Breaker Protection (EBP) limits the current draw to prevent breakers opening
- Linea Research minimal signal path design
- Class leading sonic performance achieved by the use of state of the art Amplifier technologies and highly advanced DSP algorithms using Linea Micro Detail (LMD)
- 96kHz sampling frequency provides for a nominally flat response beyond 40kHz.
- Rotary encoders, illuminated buttons and graphical display provide a rapid, intuitive and user-friendly control interface
- High speed Ethernet communications supporting DHCP, static-IP and auto-IP and direct connection to a computer without the need for a router or a switch
- Powerful Drive Module concept, abstraction from device centric to speaker based control
- Innovative Component Presets to allow individual outputs to be used for selected drivers of a loudspeaker system
- Twelve layers of Parameter Overlays for trouble-free Grouping
- Unique VX limiter providing dynamic control for passive 2-way enclosures
- Unique LIR linear phase crossover shapes giving FIR-like performance with minimal latency and without requiring a design
- Linear phase HF system EQ profiling which provides perfect integration between enclosures
- Innovative excursion control limiter with sliding High Pass Filter; limits only the damaging low frequencies
- Transducer thermal modelling provides regulation limiters, addressing long term overload
- Overshoot limiter governs amplitude of transient signals, retaining average power whilst constraining peak energy
- (Optional) Dante audio networking with automatic fall over to Analogue or AES3 (AES67 compatible)
- AES3 inputs
- (Optional) Dante audio networking output which may be routed from various positions

## Drive Modules

The 44/48 Series processor has a new way of ordering and grouping channels in order to give a more speaker-based approach to controlling, designing and recalling speaker configurations; these are called Drive Modules. A Drive Module is the Processing provided by one Input DSP Block, and a number of Output DSP Blocks, which are associated with one-another by means of routing. For example, if Input DSP Block B is routed to Outputs 3 and 4, then this is a 2-way Drive Module with Input DSP Block B forming the 'Master' control, and Output DSP Blocks 3 and 4 providing the driver-related control. Overall, this forms the processing typically for one loudspeaker sub-system. The System Engineer Drive Module control panel for this sub-system may then be used for control and monitoring of the associated speaker.

Drive Modules may be included in Module Groups, which use the Parameter Overlay feature in the Device to achieve trouble-free Grouping in the System Engineer application.

The Presets in the Device are Drive-Module centric, and are used to configure individual Drive Modules rather than the whole device.

Importantly, Drive Modules move the focus away from the processing device, and onto the loudspeaker systems.

A Drive Module Preset may be broken apart into Components, allowing any output to be used for any component within a Drive Module Preset (i.e. any driver in a loudspeaker subsystem).

See [Overview of Modules](#)

## Overlays

When the Device is used in Modules view in System Engineer, this allows the modules to be grouped into *Overlay Groups*. These groups allow various Input (master) parameters to be adjusted in *all modules* in that group, whilst maintaining independent parameter values across each group. This is achieved in the device by combining the parameters for all the layers for a given section (Gain Delay, EQ etc.). When an Overlay parameter is active, the Overlay indicator will become illuminated. The combined Gain or Delay etc. associated with a given section is shown on the module panel in System Engineer, within square brackets [ ] under the Delay and Gain for each input channel. The combined EQ curve is shown in an olive colour. The Input Mute button in System Engineer will flash if an overlay mute is active. On the device, the presence of an active overlay is generally indicated by square brackets "[ ]" after the parameter value on the display. An input overlay mute is indicated on the mute/clip indicator for that channel flashing. Note that overlay parameters cannot be adjusted on the Device itself; these can only be controlled by the System Engineer application. However, overlay parameters may be removed on the device – see [Overlay Flush](#). Note that overlays are not stored in presets or snapshots or carried in settings files.

## LIR Linear Phase Crossover Filtering

The Device also includes a new type of crossover filtering "Linear Impulse Response" (LIR) crossover filtering, which results in a Linear Phase crossover that has a constant delay regardless of frequency (unlike other types of crossover which delay different frequencies to a different extent, thus smearing the arrival time). The LIR crossover can thus be described as having a flat Group Delay response, and thus entirely free of Group Delay Distortion.

The shape of the LIR crossover filter is quite similar to a 4<sup>th</sup> order or 24dB/Oct Linkwitz-Riley filter, and maintains zero phase difference between the adjacent bands across the crossover region to keep the polar response rock steady.

### **FIR Linear Phase Equalisation**

The Input High-Shelf Equalisers use Finite Impulse Response (FIR) filtering to produce Linear Phase equalisation; that is all frequencies are delayed by the same amount, perfectly preserving the transient response. This can also be important in applications where different amounts of EQ are applied to different parts of a speaker cluster, such as to add 'Throw' EQ boost so that parts of cluster which are throwing further can have HF absorption correction added. If this EQ is not linear phase, then the zones where the speakers combine may suffer frequency response anomalies.

### **FIR Output Processing (available on some models)**

Each output has a Finite Impulse Response (FIR) filter which may be programmed using a 3<sup>rd</sup> party application for further Equalisation and phase correction. Such FIRs may be designed for Linear Phase response, either for equalisation or from linear phase crossovers.

## Audio Connections

---

### Input Connections

For each input channel there is a female XLR connector for analogue inputs. There is also one female XLR for one stream (two channels) of AES3 digital audio. Note that only two channels of AES3 digital audio are available.

The HOT, + or 'in phase' connection should be made to pin 2 of the XLR connector.

The COLD, - or 'out of phase' connection should be made to pin 3 of the XLR connector.

Pin 1 of the XLR connectors is internally connected to the chassis. The shield of the input cable should always be connected Pin 1 of the XLR to ensure that EMC performance and regulations are met.

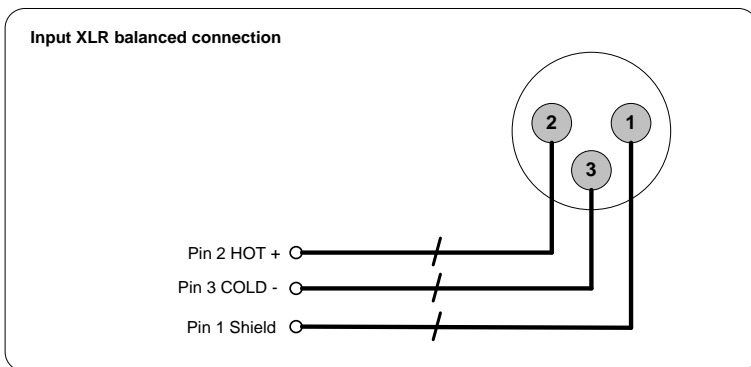

### Using unbalanced connections

Please note that the use of unbalanced connections is not recommended, however when connecting the amplifier to an unbalanced audio source, the signal conductor should be connected to XLR pin 2. The 'Cold' conductor or cable screen should be connected to XLR pin 1 with a short connection made between pin 1 and pin 3.

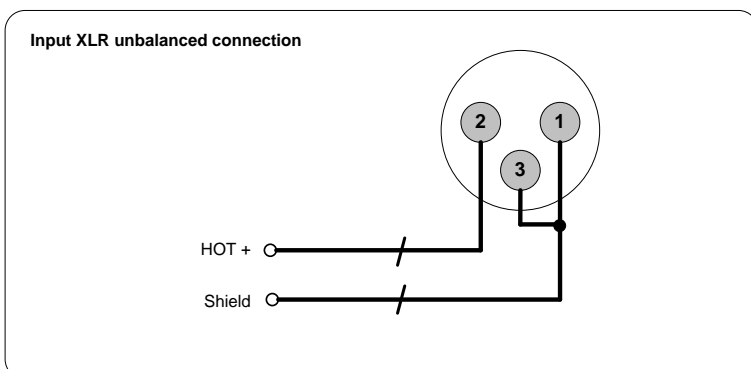



## Amplifier Output Connections

 Note : The 44M and 48M series amplifier can produce high voltages at their outputs. Always use genuine Neutrik Speakon™ connectors. Un-bridged outputs must use Class 2 or class 3 wiring. Bridged channel pairs must use Class 3 wiring. Custom wiring must only be performed by qualified personnel.

The 44M amplifier is fitted with one Speakon™ connector per amplifier channel.. The appropriate conductor terminations are shown below and on the rear panel of the unit.

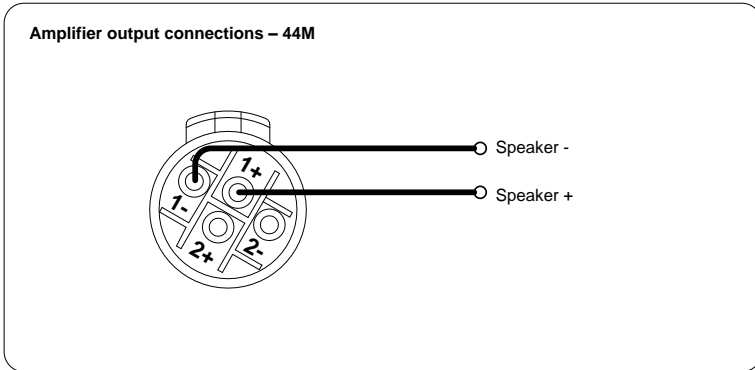

Additionally, the channel 2 output is duplicated on the Speakon™ connector for amplifier channel 1 for Bi-Amp wiring. Similarly, the channel 4 output is duplicated on the Speakon™ connector for amplifier channel 3. This can be useful for making a connection to two loudspeakers with one 4-core cable (i.e. Bi-Amp).

On the 48M model, all outputs are Bi-Amp; each Speakon™ connector carries two amplifier outputs – Channels 1&2, Channels 3&4, Channels 5&6 and Channels 7&8.

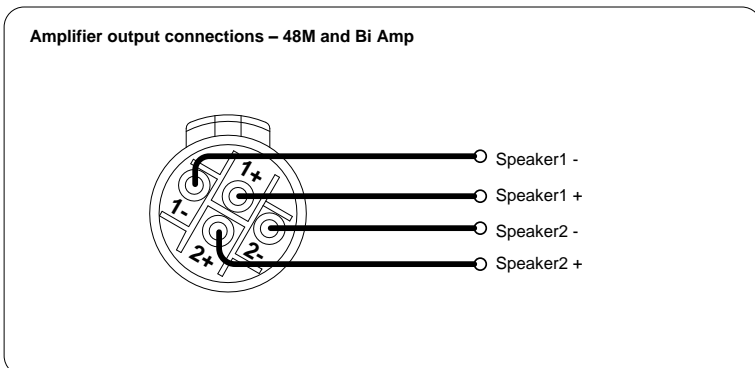

In addition, the channel 1 or channel 3 connector (all the Speakon™ connectors on the 48M model) can also be used if the pair of amplifier channels is being operated in bridged mode.

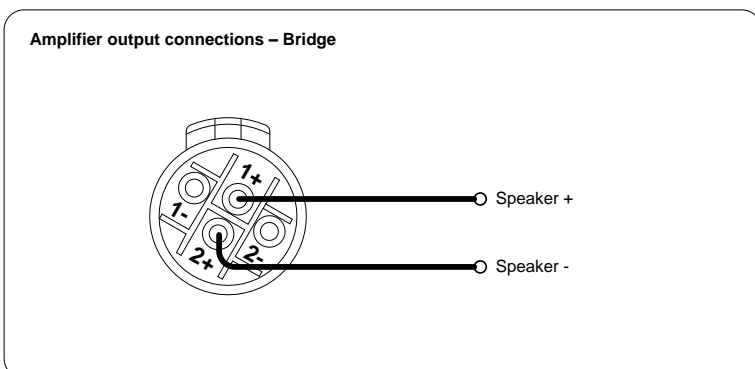

More than one speaker can be connected to each channel provided the total impedance per channel is not less than **2 ohms**. In bridged mode the minimum total impedance should not be less than **4 ohms**.

Also see [Dante Outputs](#).

### **Load Matching**

Each output of the device can be optimised to drive either a low impedance load (e.g. 2, 4 or 8 Ohms), or a Constant Voltage (C.V.) using the Load parameter in the Output menu. There are several C.V. settings (25V, 70V and 100V Line) which determine the maximum RMS voltage that the amplifier will produce. Select the one which is appropriate for the installation. A number of low impedance settings (depending on the model) are also available. Although it is not critical that this setting matches the impedance of the connected load, this will maximise the power that is available for the load. An 'Auto' setting is also available, which optimises the maximum voltage/current available to maximise the output power for a given measured load impedance.

## Panel Layouts

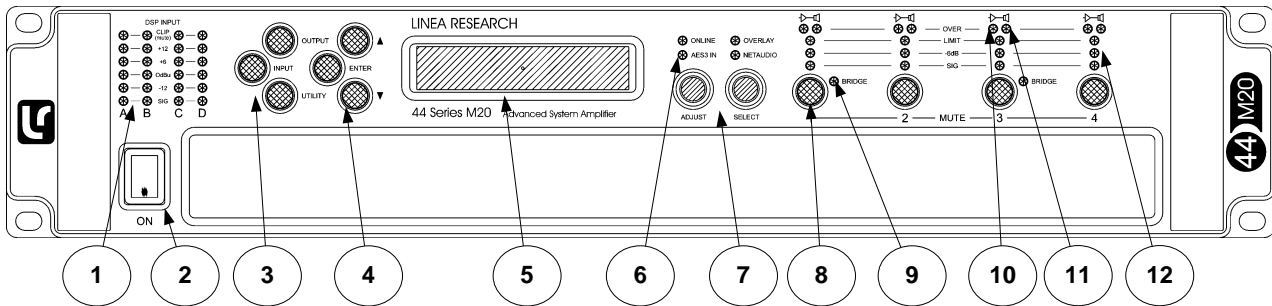

(The 44M is illustrated. The 48M is similar, but with more output indicators and mute buttons)

1. **Input Signal Indicators-** A set of five indicators show “Sig”, “-12”, “OdBu”, “+6” and “+12” and “Clip (mute)” for each of the DSP inputs “A” “B” “C” “D”. The signal present Indicators operate at approximately -40 dBu. The **Clip/mute** Indicators warn the user of input overload and operate at 1dB before clip. This indicator also shows a muted input
2. **Power Switch-** Applies mains power to the device. If the device has entered Sleep mode, it may be woken up again either from the System Engineer application, or by switching this switch off, then on again.
3. **Menu Buttons-** There are three buttons to determine which section of the device to view or edit. The <OUTPUT> button displays pages of parameters associated with a particular output channel. The <INPUT> button displays pages of parameters associated with a particular input socket or input DSP channel. Pressing <INPUT> or <OUTPUT> buttons repeatedly will scroll through the inputs/outputs of the device. After the last channel, navigation returns to the Home screen. The <UTILITY> button displays pages of miscellaneous parameters not associated with any particular channel. Whilst in Edit mode, one of these three buttons will be illuminated. They are mutually exclusive – pressing one of the buttons will deselect any others that are active. Pressing Utils will escape back to the Home screen.
4. **Page Selection Buttons-** When one of the buttons <INPUT>, <OUTPUT> or <UTILITY> is illuminated, the up <▲> and down <▼> arrows will also illuminate, informing the user that these buttons may be used to scroll through the various pages of parameters that may be viewed and edited. The <ENTER> button is used to confirm an operation such as storing or recalling a preset or snapshot. It will illuminate when the user is being invited to press it. It will flash when warning the user that pressing this button will activate an important function.
5. **Graphical Display-** This will show the Home screen; a useful overview of channel allocation. On most pages the currently selected channel and parameter information is displayed on the upper part of the screen and the parameter value on the lower part of the screen. The screen contrast can be changed by pressing the <UTILITY> button to navigate to “Screen” and using the encoders to change the percentage; this can also optimise the viewing angle.
6. **Status Indicators-** The “OVERLAY” indicator shows when there are parameters active on a group layer, which the user cannot access through the front panel of the device (see [Overlay Flush](#)). The “NETAUDIO” indicator shows that a networked digital audio card (e.g. Dante) is installed and routed (Such as Dante™). The “ONLINE” indicator has three states: *Off* – the unit is offline and not connected to a computer or network. *Flashing* – the unit is searching for an IP address; if the unit does not find an IP address the unit will assign itself an IP address automatically and the indicator will stop flashing. *On* – the unit is online and connected with software. IP settings can be viewed or changed within the <UTILITY> pages. The “AES3 IN” indicator illuminates when one or more of the inputs is using an AES3 source.
7. **Parameter Encoders-** Two velocity sensitive parameter encoders are used to adjust parameters shown on the display. Up to three parameters at a time are displayed on the screen. The parameter name is shown above the parameter value in each of the three screen sections. Use SELECT to highlight the parameter, then ADJUST to change it.
8. **Bridge Indicator-** This will illuminate when the channel pair is in Bridge mode. The controls for the left channel of the pair will determine the settings. See [Bridge Mode](#)
9. **Mute Buttons-** DSP output mute status is indicated and controlled by an illuminated button for each channel. These flash when the entire unit is muted from the AUX port or from System Engineer Mute-All, or if this channel has been muted by the protection systems.
10. **Amplifier Indicator-** This indicates when the amplifier protection systems are reducing the gain to keep the parameters of the amplifier within specification, or when that the channel is clipping.
11. **Driver Indicator-** This indicates a signal 6dB higher than the limiter threshold, or when the threshold of the excursion limiter has been exceeded, or when the thermal limiter is active. Please note that because of the long release time of the thermal limiter, this indicator may remain illuminated for several seconds after signal on that channel is reduced.
12. **Limiter Indicators-** The output indicators shows the status of the limiter and output level. The level indicated is that before the limiter, referenced to the limiter threshold. The <SIG> indicator shows when a signal is present on the output. The second indicator <-6dB> shows that the signal has reached 6dB below the limiter threshold. The third <LIMIT> indicator indicates that the threshold of that output channel has been reached.

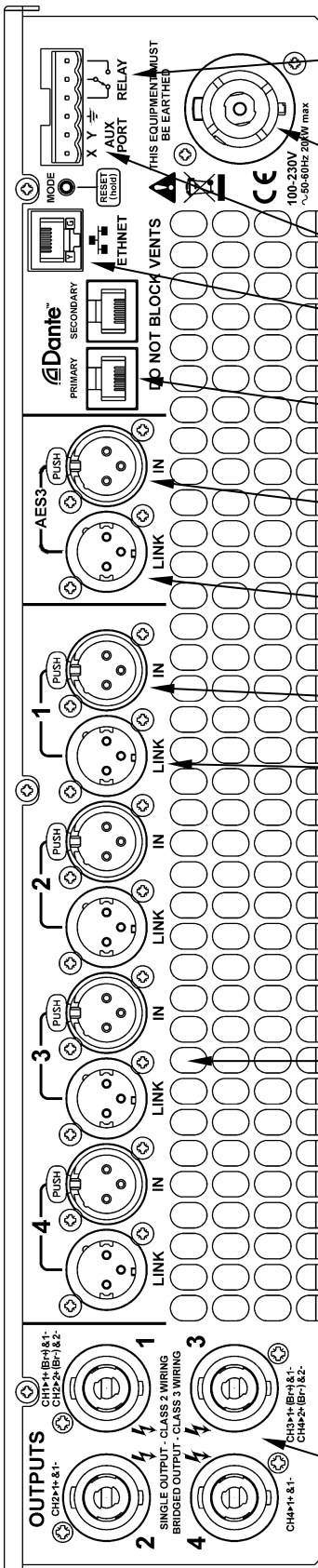

**Relay output-** This isolated relay output may be used to indicate abnormal conditions to external monitoring apparatus. See the [Fault Relay](#) section.

**Mains Power Inlet-** Connection to the mains supply must only be made with a genuine Neutrik™ Powercon™ 32A connector. The amplifier is designed to operate from a nominal mains voltage between 100V and 230V, 50/60Hz without re-configuration. NOTE: The amplifier **must** be connected to a suitable mains earth; failure to do so will affect safety, performance and will invalidate the manufacturer's warranty.

**Auxiliary Port-** The auxiliary port may be configured for a variety of purposes. See the [Aux Port](#) section.

**Ethernet Communications Port-** Used for remote control and monitoring via an external device, typically a Personal Computer, running an application such as Linea's System Engineer, or by using the simple Tipi protocol.

**Networked Audio Ports-** Versions of the amplifier are available that support networked audio. If this option is not included a blanking plate will be fitted. There are several options for networked audio including Dante™ from Audinate™ Please consult your vendor for more details. NOTE: It is not possible to retrofit this option.

**AES3 Digital Audio Input Connector-** The Input is fully balanced, transformer isolated and terminated. It is wired: pin-1 to ground, pin-2 data+ & pin-3 data.

**AES3 Audio Link Connector-** The Link connector carries a buffered version of the signal on the AES3 input connector. In the event that an amplifier is not powered, AES3 input and Link are directly connected. Do not 'daisy-chain' more than 8 amplifiers from a single AES3 source.

**Analogue Audio Input Connectors-** All audio connections are fully balanced and wired: pin-1 to chassis (as required by the AES48 standard), pin-2 hot & pin-3 cold.

**Analogue Audio Link Connectors-** These are directly connected to their corresponding analog input connectors.

**Air Exhaust Vents-** These must not be obstructed and there must be a clear path for hot air to exit any rack system.

**Loudspeaker Connectors (44M)-** The numbered connectors carry their corresponding channels on the 1+ and 1- terminals. Connector 1 also carries the output for channel 2 on terminals 2+ and 2-. Similarly, connector 3 also carries the output for channel 4 on terminals 2+ and 2-. For Bridged mode, use terminals 1+ and 2+ of either CH1 or CH3. Only use genuine Neutrik™ Speakon™ connectors.

**Loudspeaker Connectors (48M)-** Odd channel numbers are connected to the 1+ and 1- terminals, even channel numbers are connected to the 2+ and 2- terminals. For Bridged mode, use terminals 1+ and 2+. Only use genuine Neutrik™ Speakon™ connectors.

## Operation

---

### Starting up the unit

When power switch is switched on the unit will go through its start-up cycle, checking all the sub-systems as it does so. Along the way, the screen will inform you of its progress. Once this is complete the display will then show the Home screen indicating drive module configurations.

### Overview of Modules, Presets Components and Snapshots

A **Drive Module** represents a loudspeaker subsystem (e.g. Sub and Composite), and comprises one input channel and a number of output channels, associated with one-another by routing. The size of the Drive module is determined by the number of outputs in it. The device may contain up to four Modules.

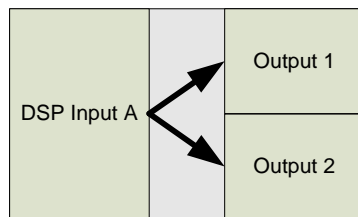

A **Module Preset** is a collection of settings (parameters) for a Drive Module of a particular size. The Preset contains a set of parameters for one input and a set of parameters for each of the outputs in the module. When a Module Preset is recalled, it will automatically change the routing between Input DSPs and Outputs, consuming a number of outputs according to the size of the Drive Module. Recalling a Module Preset thus always creates a Drive Module with consecutive outputs.

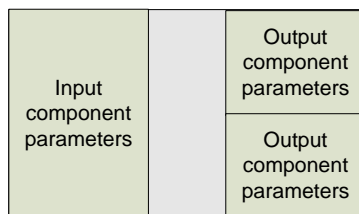

A **Component** is a collection of settings (parameters) for one (input or output) channel. Any one of the output components in a Module Preset may be recalled to any individual output.

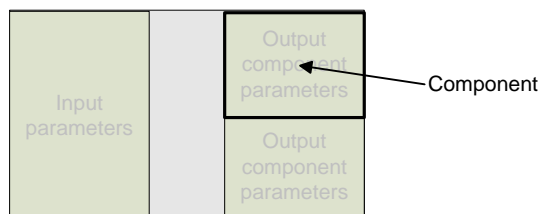

These concepts are depicted in the System Engineer application as in the following example of a 2-way Module:

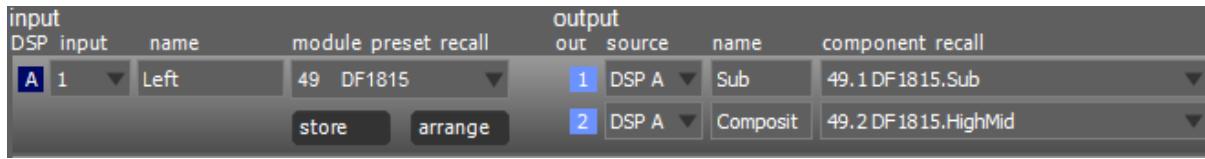

A **Snapshot** is a device-wide representation of most of the settings in the device. This is represented as four Input Component numbers, four (44M, 44C) or eight (48M, 88C) Output Component numbers, plus a number of machine-centric settings such as routing and Input/Output Analogue/Digital selection etc.

Device Settings	Input A component number	Output 1 component number
	Input B component number	Output 2 component number
	Input C component number	Output 3 component number
	Input D component number	Output 4 component number

## Navigation

Parameter navigation and adjustment on the 44/48 Series is very straightforward. There is no concept of drilling down deeper into hidden menus; every parameter is accessible by simply scrolling across a 'map' of parameter pages which can be thought of as placed on a 2-dimensional grid. Horizontally across the width of the grid are the various channels, and vertically up and down the grid are the parameter pages for each section of processing.

To view a parameter, repeatedly press the desired <INPUT> or <OUTPUT> channel button until the desired channel is reached. Then repeatedly press the up <▲> and down <▼> buttons to scroll through the processing parameters for the selected input/output.

Two encoders allow you to select and adjust a parameter. Often, several parameters will be shown in various zones on the display. To select a parameter for adjustment, turn the right-most encoder such that the parameter you wish to adjust is highlighted. Then turn the leftmost encoder to adjust the value of that parameter. Turning this encoder clockwise will increase the value of a parameter, or anticlockwise will decrease it. The encoders are velocity-sensitive so turning an encoder rapidly will cause the action to 'accelerate', so the value changes more rapidly.

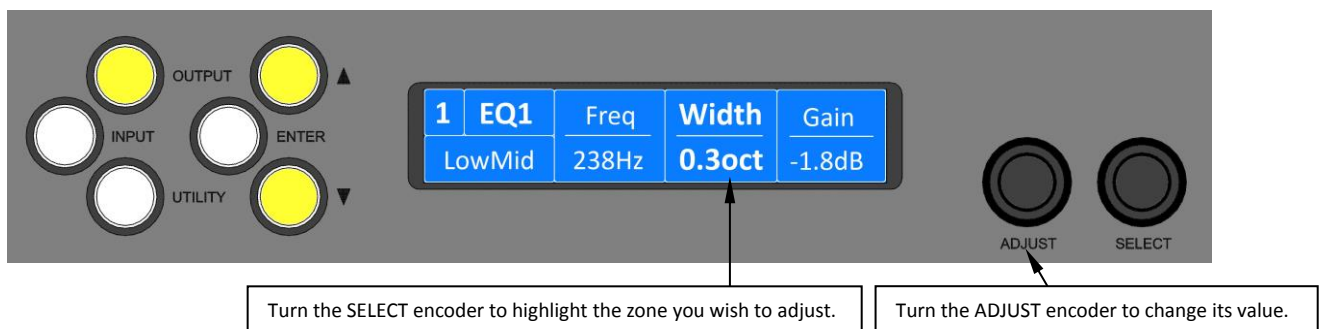

## The Home Page

The Home Page presents an overview of the configuration of the device. It indicates the user-defined Device Name at the top, and shows the four [Drive Modules](#). In each Drive Module the top line shows the Input DSP channel ('A', 'B' etc), and the name the user has given to this channel. The bottom line shows the physical input number, and a list of the outputs which are routed from the Drive Module.

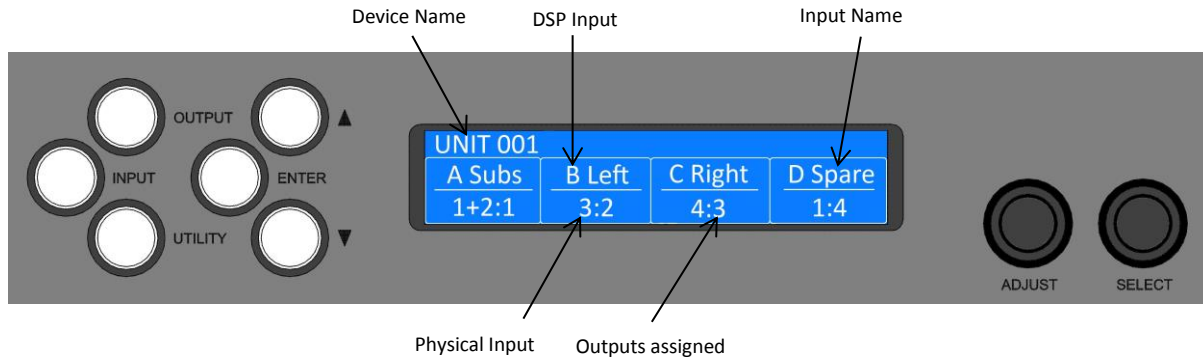

## Drive Modules

The 44/48 Series uses Drive Modules to represent loudspeaker sub-systems. Drive modules result in a less processor-centric and more speaker-orientated system design. A drive module is defined as the processing provided by one Input DSP, and a number of outputs, which are associated with one-another by means of routing. For example, if Input DSP B is routed to outputs 3 and 4, then this is a 2-way Drive Module; input DSP B forming the 'master' control, and output DSP 3 and 4 providing the driver-related control. The Input DSP parameters then control the Drive Module (and thus the speaker sub-system). The Drive Module control panel in the System Engineer application is then used for control and monitoring of this sub-system.

## Drive Module Presets

Presets do *not* change the settings device-wide. Rather, recalling a Module Preset creates a Drive Module by 'consuming' a number of consecutive outputs and setting up routing between the Input the preset was recalled on and those outputs. The parameters in that Drive Module are then set according to the parameters in the components in the Module Preset.

Note however, that modules with non-consecutive outputs can be created by manually manipulating the routing, and then recalling [Component Presets](#) to the individual outputs. The resulting system can then be stored in a [Snapshot](#). Such a Module cannot be saved in a Module Preset.

**Note: When a Module Preset Recall consumes outputs to construct a module, it treats a pair of Bridged outputs as a single channel, so recalling a 2-way Module Preset will consume 3 output channels if a Bridged pair is encountered. See [Bridge Mode](#)**

**Note: DSP inputs are not the same as physical inputs. The 44/48 Series has four audio inputs and four DSP inputs. This is a matrix mixing system where any physical inputs, be they analogue, AES3 or networked audio feeds, can drive any number of DSP inputs.**

## Component Presets

A Component Preset represents the processing for just one output. Any part of a Module Preset may be recalled to any one output. A Drive Module comprised of parameters which have been recalled to its outputs

using Component Preset Recalls can then be saved into another [Module Preset](#) provided the outputs remain consecutive (i.e. you have not changed the routing manually). If the routing has been changed manually, then the whole arrangement may be saved into a [Snapshot](#). Also see [Snapshots](#) and [Recalling Components](#).

## Factory Module Presets

The device may contain a library of *Factory Presets* designed to suit a range of enclosures.

*Factory Presets* may contain some parameters that are fixed and hidden from view; the remainder of the parameters are available for user manipulation. The number and type of hidden parameters is dependent on the Factory Preset, typically crossover frequencies, output delay and some EQs are hidden; those settings that are a function of the loudspeaker cabinet design and should not require adjustment for different applications. *Factory Presets* are locked (as indicated by a 'box' symbol after the Preset name) so they cannot be overwritten. The user can, however, store an edited version of a Factory Preset in any free preset location.

In addition to the *Factory Presets* the device may have further '*Skeleton Presets*' which will help to create new presets. They can be used to develop settings for any loudspeaker combination and are recalled in the same way as the *Factory Presets* described above. These Presets are also usually locked but the user can name and store their own edited versions in any free preset location.

## Storing Module Presets

Once a drive module has been created it can be stored by pressing the <INPUT> button until the edited channel is reached, then pressing the down <▼> button until **store** page is reached. Using "ADJUST" encoder will change the preset number. When the destination preset is reached, pressing the <ENTER> button will enable the name associated with that preset to be changed. Once the name changing is active, the character to be changed will be highlighted and the "ADJUST" encoder will edit the character. Using the "SELECT" encoder will move through the character positions. Once the new preset name has been assembled, the operation can be confirmed by pressing the <ENTER> button, then a message will be displayed, "Enter to confirm or ▼ to exit"; pressing <ENTER> will store the preset.

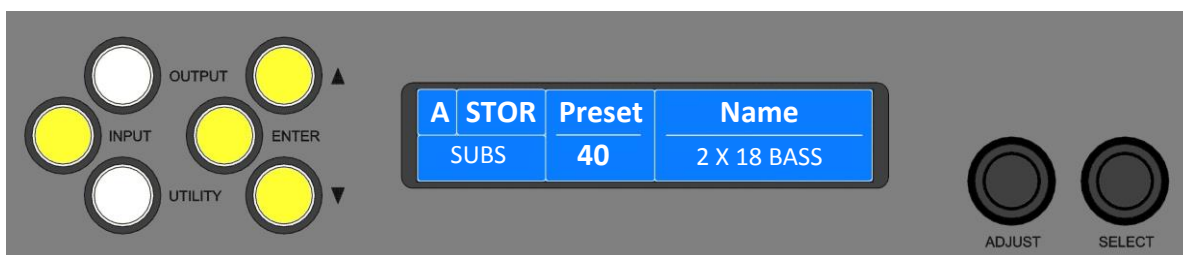

**Note: Storing a Drive Module preset for a module which is not configured with consecutive outputs is not permitted.**

**Note: When storing a Drive Module preset on the device, Component Names cannot be edited. To change Component names, the Module Preset must be saved in the System Engineer application.**

## Recalling Module Presets

To recall a Drive Module preset, press the <INPUT> button, then use the down <▼> button navigate to the RECL Preset page. Using the "ADJUST" encoder will scroll through the presets available. When the desired preset is reached, pressing <ENTER> will display the message "Enter to confirm or ▼ to exit", pressing <ENTER> will recall the preset. Note that presets do not contain and do not disturb parameter Overlays. See [Overlays](#)



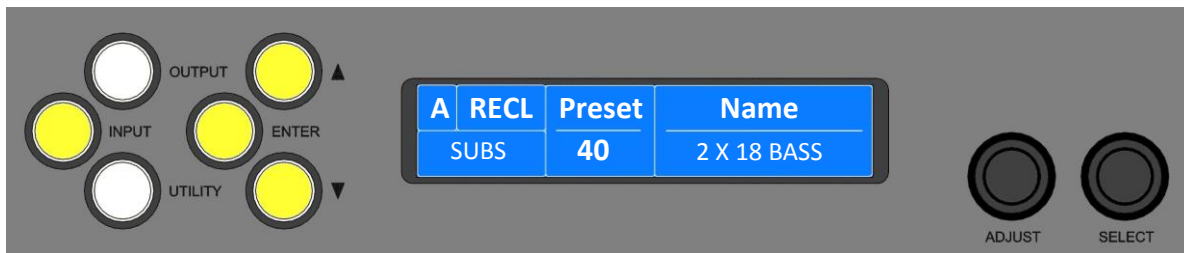

## Recalling Components

To recall a Component Preset (to a single output), press the <OUTPUT> button, then use the down <▼> button navigate to the RECL Preset page. Using the encoder, “A” will scroll through the component presets available (as indicated by the ModulePreset.Component number and ModulePreset.Component name). When the desired component is reached, pressing <ENTER> will flash the Enter button. Pressing <ENTER> again will then recall the component preset. Note that component presets do not contain and do not disturb parameter Overlays. See [Overlays](#)

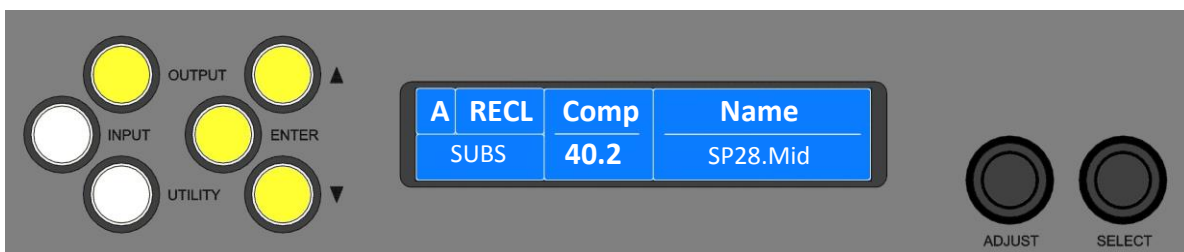

Also see [Snapshots](#).

## Input

### AES3 Inputs

In addition to the usual analogue inputs, the Device can also accept AES3 digital inputs. When a DSP input channel is assigned to an AES3 channel, the “AES3” indicator will illuminate.

There is no ‘standard’ for the relative gains between Analogue and AES3 so depending on the levels delivered by the audio source, it may be necessary to adjust the digital input gain trims to normalise them. It is possible to adjust the gain of the AES3 input using the Input Trim AES3 Gain parameter. For example, to achieve 0dBFS = +18dBu, set the AES3 trim to -2dB. To achieve 0dBFS = +24dBu, set the trim to +4dB.

This device will automatically lock onto any sample rate within the range 28kHz and 108kHz.

### Networked Audio (Dante) Inputs

When the Digital Audio Network option is fitted, it is possible to select any channel(s) as being sourced from this network. To do this, connect the audio network connection to the connection on the rear of the Device, and set the relevant Input Type menu Type parameter to “Dante” (for example.)

When the Digital Audio Network input is installed and routed, the “Net Audio” indicator above the encoders will illuminate. This indicator will come on even if there are no cables plugged into the networked audio port on the Device.

As for the AES3 inputs, it is possible to set the relative gain between an Analogue input and the signals sourced from the Digital Audio Network using the Input Trim Dante gain parameter.

The amplifier will automatically select the correct sample rate from the incoming stream.

For other details on the operation of the Digital Audio Network, please refer to the relevant manufacturer’s documentation.

Note that the 48M model may route Dante input 5..8 directly to output processing channels 5..8 without passing through any input processing.

### **Automatic Input Selection (Fallover)**

It is possible to configure the input selection to be automated. The Input TYPE screen has a Fallover parameter, which defaults to Manual, allowing you to select what Type of input you wish to use. When Fallover AES3>Analogue is selected (on an input channel which supports AES3), then the AES3 source will be automatically selected if it has a valid audio stream on it. If the AES3 stream should fail, then Analogue is automatically selected instead.

When Fallover Dante>Analogue is selected (when the Dante option is fitted), then the Dante source will be automatically selected if it has a valid audio stream on it. If the Dante stream should fail, then Analogue is automatically selected instead.

Similarly, it is possible to select Fallover Dante>AES3 on a channel that supports AES3 and the Dante option is fitted.

The 'Auto' setting allows the highest priority input source that is active to be automatically selected, so the user could just plug a source into any input and it will be automatically selected. The priorities are: Dante first, AES3 second, Analogue third.

Note that any automatic selection will take precedence over manual selection, so if you try to manually select Dante when there is no valid Dante stream, then it will revert to the fallover input source.

This feature is not available for Dante inputs 5-8 on a 48M model.

### **Gain and Polarity**

The gain page of the input channel selected allows users to increase or decrease the amount of signal going into the selected input. Using the "SELECT" encoder to highlight the Gain value allows the value to be changed by the "ADJUST" encoder in 0.2dB steps from -40dB to +20dB. The presence of an active Group Overlay parameter is indicated by the '[' symbol (See [Overlays](#)). This page will also allow users to change the polarity of the selected input from normal to reverse. And to mute the selected channel.

### **Delay**

The delay page which controls the amount of delay associated with the input channel selected and is adjustable from 0 to 998ms. The delay parameter is adjustable in fine steps at low values; the adjustment becomes progressively coarser as the value increases. The presence of an active Group Overlay parameter is indicated by the '[' symbol. See [Overlays](#).

### **High Pass Filter**

System high pass filtering is provided for the input signal. Filter type is selectable from 1<sup>st</sup> order, Butterworth, Bessel, Linkwitz-Riley and Hardman. Filter slopes of up to 4th order or 24dB / octave are provided. Not all filter types are available in all slopes. For example 18dB / octave Linkwitz-Riley filters do not exist.

The Hardman type filter is always described by its order as the filter becomes progressively steeper rather than following a linear slope so a dB/octave description is not accurate.

### **Parametric Equalisation**

There are nine stages of equalisation available for each input channel, three shelving filters and six parametric filters.

### **FIR Shelving EQ**

The Input High Shelf EQ is implemented using a Finite Impulse Response (FIR) filter, and exhibits a linear phase response; that is all frequencies are delayed by the same amount. This can be important in applications where

different amounts of EQ are applied to different parts of a speaker cluster, such as to add 'Throw' EQ boost so that parts of cluster which are throwing further can have HF absorption correction added. If this EQ is not linear phase, then the zones where the speakers combine may suffer frequency response anomalies.

Being a linear phase FIR equaliser, this necessarily introduces some latency delay, which is constant regardless of the settings. However, when the 'Enable' parameter is set to "Off", it is removed from the signal path entirely, so it does not add any latency. In this page you can change the frequency parameter from 2kHz to 20kHz, enable/disable the filter, and change the cut or boost in 0.2dB increments. The presence of an active Group Overlay parameter is indicated by the '[' symbol being appended to the Gain value (See [Overlays](#)). The filter (and its associated latency) can be completely removed by setting the enable parameter to the "Off" position. Note that this EQ can only be used in Module Groups if set to 'On'.

Also see [Latency Delay](#).

### **Parametric Filters**

Parametric filters are defined by frequency, bandwidth and gain. The frequency is adjustable over the range from 10Hz to 25.6kHz. The bandwidth shown as Width on the screen, ranges from 0.10 octaves to 5.2 octaves. Bandwidth can be shown and adjusted as Q or Octaves (Oct). Gain is adjusted in 0.2dB increments. The presence of an active Group Overlay parameter is indicated by the '[' symbol being appended to the Gain value. See [Overlays](#).

Also see [Bandwidth Units](#) in Utilities.

### **Routing**

Routing allows users to route any physical analogue or digital signal channel to any DSP input. This is effectively a matrix mixing system where all DSPs can be driven from any one input, or from combinations of inputs "1+2", "3+4", "1+3", "1+4", "2+3", "2+4", "1+2+3", "1+2+3+4", "1+2+4", "1+3+4" or "2+3+4". Summed inputs each have appropriate attenuation so that a sum of largely similar programme material remains at the correct calibrated level.

### **Output**

#### **Gain and Polarity**

The gain page of the output channel allows users to increase or decrease the relative signal gain for the selected output. The Gain value may be adjusted in 0.2dB steps from -40dB to +20dB. This page will also allow users to change the polarity of the selected output from normal to reverse.

#### **Delay**

The delay page controls the amount of delay associated with the output channel selected and is adjustable from 0 to 998ms. The delay parameter is adjustable in fine steps at low values; the adjustment becomes progressively coarser as the value increases.

#### **High and Low pass Filters**

High pass and low pass crossover filtering is provided for the output signal. Filter type is selectable from 1<sup>st</sup> order, Butterworth, Bessel, Linkwitz-Riley, Hardman and LIR Linear Phase. Filter slopes of up to 8th order or 48dB / octave are provided. Not all filter types are available in all slopes. For example 18dB / octave Linkwitz-Riley filters cannot be selected because they do not exist.

The Hardman type filter is always described by its order as the filter becomes progressively steeper rather than following a linear slope so a dB/octave description is not accurate.

## **LIR Crossover Filtering**

Unique to Linea Research, “Linear Impulse Response” (LIR) crossover filtering gives a Linear Phase crossover which has a constant delay regardless of frequency (unlike other types of crossover which delay different frequencies to a different extent, thus smearing the arrival time). The LIR crossover can thus be described as having a flat Group Delay response, and thus entirely free of Group Delay Distortion, this is exactly the same as can be provided by common FIR filtering but without the complications and disadvantages inherent with the FIR technique.

The shape of the LIR crossover filter is similar to a 4<sup>th</sup> order Linkwitz-Riley filter, and maintains zero phase difference between the adjacent bands across the crossover region to keep the polar response rock steady.

Note that very narrow bandwidths are not possible with this crossover type. If the Low Pass frequency is too close to the High Pass frequency, then the filter will ‘mute’.

Linear Phase filtering necessarily introduces delay; the laws of physics demand it. To keep this delay to a minimum, it is recommended that more conventional crossover shapes (such as Linkwitz-Riley) are used for the very lowest frequency high-pass edge, particularly if this is less than perhaps 100Hz, which is well below the frequency thought to cause audible ‘Group Delay Distortion’.

This constant delay will depend on the lowest high-pass frequency used in the crossover filters in a given Drive Module.

*Also see the section on [Latency Delays](#).*

## **Parametric Equalisation and All-Pass Filters**

There are ten different EQ filters; two shelving filters and eight parametric filters. Parametric filters are defined by frequency, bandwidth and gain. The frequency is controlled over the range from 10Hz to 25.6kHz. The bandwidth, shown as Width on the screen, ranges from 0.10 octaves to 5.2 octaves. Bandwidth can be shown and adjusted as Q or Octaves (Oct). Gain is adjustable in 0.2dB increments.

Any of the six Parametric filters can be used as All-Pass filters. When a filter is set to All-Pass mode, the Gain parameter value will show as “AllPass” on the display. This setting may only be engaged by right-clicking the EQ ‘icon’ in the EQ window of the System Engineer panel.

*Also see [Bandwidth Units](#) in Utilities.*

## **FIR Filter (available on some models)**

Each output supports a 768 tap Finite Impulse Response (FIR) filter which may be programmed using a third party application, such as the Eclipse Audio FIR Designer software, and loaded via the System Engineer application.

FIR filters may be used for equalisation, phase manipulation or for crossover filtering with linear or arbitrary phase response.

The filter itself cannot be programmed from the front panel, but the Name of the FIR design is shown on the display, and the action of the filter may be enabled/disabled.

## **Limiters**

The 44/48 Series includes three limiters in the output signal path. Please note that whilst the Limiters in this product offer protection for amplifiers and drivers, they can never protect from all possible scenarios, therefore Linea Research is not responsible for any damage which might occur.

## **VX Limiter (Unique to Linea Research)**

This is a peak-detecting RMS-calibrated signal limiter. The VX Mode parameter determines the style of limiter. When Virtual Crossover (VX) mode is off, the limiter is controlled in a conventional manner; the only controls being Threshold and Overshoot.

The Overshoot limiter prevents the signal from exceeding threshold by more than a predetermined amount during the attack phase of the main limiter. The optimal Overshoot setting is usually about 8dB. Lower Overshoot settings will sound progressively 'harder'.

When VX mode is engaged, the user can choose the crossover point of a 'virtual crossover', which incorporates two limiters per output so the user can individually limit the drivers in a passive 2-way enclosure using individual thresholds, and optimised attack and release characteristics for each. The Threshold of the second 'Hi' limiter is set relative to the threshold of the first 'Lo' limiter.

The effect of the VX threshold and split frequency on the Limiter curve can be seen in System Engineer.

This Limiter introduces some delay. In non-VX mode, this delay will depend on the lowest high-pass frequency used in the crossover filters in a given Drive Module. In VX mode, the delay is related to the Split frequency. This delay will be applied to all of the outputs in a given Drive Module to keep them in phase.

*Also see [Latency Delays](#)*

## **Tmax Thermal Limiter**

The Thermal Limiter is intended to protect the driver against damage due to over-heating. It models the temperature of the driver, and constrains the output signal level in order to keep the average output power below a predetermined limit, applying attack and release characteristics to go some way towards modelling the complex thermal circuit of a driver's voice coil and magnet assembly.

Three parameters are available for adjustment:

**Threshold** – the continuous RMS voltage which the driver should be able to withstand. This is calibrated at the output of the amplifier. The Thermal Limiter can be defeated by setting the Threshold to the maximum "Off" value.

**Attack** – The time-constant of the speed at which the driver heats up (in seconds).

**Release** – The time-constant of the speed at which the driver cools down (expressed as a multiple of the Attack time).

## **Xmax Excursion Limiter**

The Excursion Limiter protects the driver against excessive linear movement of the cone and voice-coil which could otherwise cause mechanical damage. Since this movement (excursion) is largely related to the inverse of the signal frequency, drivers are prone to being damaged by very low frequencies. This limiter is progressively more sensitive at lower frequencies and, rather than varying the gain to provide the limiting action, it uses a sliding high-pass filter to progressively curtail the low-frequency response, effectively limiting the linear excursion to below the X-max specification of the driver.

To set the limiter up, it is necessary to know the shape of the family of Excursion vs. Frequency curves of the driver for various drive voltage levels. A curve should then be chosen where the slope is high where it passes through the specified X-Max value for the driver. The peak voltage and frequency of this point should then be noted.

The Xmax limiter is usually then set up using just two parameters:

**Threshold** – the peak voltage of the point arrived at above. This is calibrated at the output of the amplifier.

The Excursion Limiter can be defeated by setting Threshold to the maximum "Off" value.

*Frequency* – The frequency at which the above threshold voltage is appropriate.

A further parameter “*Min*” may also be available for more advanced applications. This allows the increasing limiting action at lower frequencies to level-off below a certain frequency. In most application, this would be left set to its default value of 5Hz.

Note: For further information on setting up limiters, please see the Application Note DE3457 *Setting Up Limiters*.

### **Bridge**

When an amplifier pair is set to Bridge Mode, it uses two amplifier channels to drive one loudspeaker with greater power. In this mode, only one set of Output controls is active per pair of amplifier channels since both of the amplifiers in the pair are driven with the same signals, as determined by the left-hand (lower numbered) channel of the pair controls. Bridge settings should be set up *before* recalling [Drive Module Presets](#). Module Preset Recall will see a bridged pair of outputs as a single channel.

Bridge Mode is enabled or disabled in the AMP page for a given odd numbered Output. When enabled, the Bridge indicator will be illuminated between the bridged channels.

When Bridged, the partner (even numbered) channel will not show any signal on the limiter meter, and the Mute button will not operate, neither will you be able access any of its parameters for adjustment. The Amplifier protection indicator however will still operate.

### **Routing**

Outputs can be driven from any DSP input. This routing is the fundamental means by which Drive Modules are created. When a Module Preset is recalled, automatic routing will always consume outputs consecutively alphabetically and numerically. However, non-consecutive Drive Modules may be created using manual routing and [Recalling Components](#). See the [drive module](#) section of this user manual for more information. Note that the 48M model can route Dante inputs 5..8 directly to output processing for outputs 5..8, thus bypassing input processing.

### **Dante Outputs**

When fitted with the Dante option, it becomes possible to route signals to the Dante Outputs. The signal on each of these Dante Outputs may be selected from one of the following:

- “Input” – Selects the signal which is being presented to the input of the input processing channel for the similar numbered input channel (i.e. the input of the ‘Input DSP’)
- “Input DSP” - Selects the signal which emanates from the output of the input processing channel for the similar numbered input channel (i.e. the output of the ‘Input DSP’)
- “Pre Mute” – Selects the signal at the output of the equalisation section of the similar numbered output channel (i.e. the fully processed output signal before Gain, Mute and Limiting functions)
- “Post Mute” – Selects the signal at the output of the Gain, Mute section of the similar numbered output channel (i.e. the fully processed output signal before the Limiter functions)
- “Post Limiter” – Selects the signal at the output of all the output processing functions (i.e. the fully processed output signal, identical to that of the main amplifier output)

For further clarity, please see the [Processing Block Diagram](#).

### **Driver**

The optimal drive level may be adjusted for a given driver impedance using the *Load* parameter. See [Load Matching](#). The live measured impedance value is also shown on the Driver page. Since the device can only measure this when there is a signal, the impedance is indicated as “?” when there is insufficient signal level to perform a measurement.

## Utility Pages

### Screen Contrast

The Screen page in the “**UTILITY**” section adjusts the contrast (and optimal viewing angle) of the screen from 0-100% in 1% increments.

### Stereo Linking

Stereo linking is available between DSP Drive Modules A & B and between C & D. Changing a parameter in either of the stereo linked Drive Modules will change the other linked Drive Module. Stereo linking is controlled by the **STEREO** page in the “**UTILITY**” menu.

Note: Stereo linking will only work when the linked Drive Modules are of equal size.

Note: Stereo Linking state is not stored in Presets (but is stored in Snapshots)

### Version

The Model Name of the device may be viewed in the “**VER**” page of the “**UTILITY**” menu, along with the version number of the product firmware, and the version number of the Dante option (if fitted).

### Dante Name

When the Dante option is fitted, the name given to the Dante node of this device in Audinate’s Dante Controller application is visible in this screen. This allows you to associate the Dante Name with the Device Name. We would recommend you make these alike. You can check which Device a given Dante node is in by clicking the ‘ID’ icon in the Dante Controller application, which will cause the device to flash its screen.

### Current Ethernet IP Address

This may be viewed in the “**IP Curr**” page of the “**UTILITY**” menu. This value cannot be edited.

### IP Mode

The Ethernet IP address may be automatic “**Auto**” or may be a fixed static value “**Static**” as determined by the “IP Mode” page of the “**UTILITY**” menu.

**WARNING – Do NOT use Static mode unless your IT system specifically requires it. Auto mode should always be used where possible since in this mode, the Device can always be ‘discovered’ by the System Engineer application. When in Static mode, the IP Address will flash on the Home screen.**

Also see [Ethernet Configurations](#).

### IP Static

This allows the Static Ethernet IP address to be adjusted by the rotary encoders on the IP Static page of the “**UTILITY**” menu. This page will only be visible when in Static mode.

### Store Snapshot

This page of the “**UTILITY**” menu allows a Snapshot of the device to be stored.

Also see [Snapshots](#).

### Recall Snapshot

This page of the “**UTILITY**” menu allows a Snapshot to be recalled.

Also see [Snapshots](#) and [Aux Port](#).



## Bandwidth Units

This page of the “UTILITY” menu allows the Bandwidth of Parametric Equalisers to be viewed and adjusted in either Octaves or ‘Q’.

## Aux Style

This page of the “UTILITY” menu allows the action of the Aux port to be viewed and adjusted.

Also see [Aux Port](#).

## ECO

This page of the “UTILITY” menu allows the device to save power by going into a low power mode when it is not being used.

Standby is a fast mode which saves some energy, but will wake-up very quickly if an audio input is detected. The associated Standby Time parameter allows the amplifier to automatically go into power-save if no audio signal has been detected for a period of time. This function can be defeated by setting the latter control to Manual. Linea would strongly advise leaving it set to automatic however as there is no negative consequence to doing this since ‘wake-up’ on detecting the presence of an audio input signal is instantaneous.

The Standby Now ‘parameter’ allows the amplifier to be put into standby mode manually when it is not being used. While the amplifier is in Standby, the ‘Up arrow’ button indicator will slowly pulsate. Pushing this button will wake the device out of Standby.

Sleep is a deep power save mode which saves the most energy, however it will take a small number of seconds for the amplifier to wake-up, and it may only be woken up manually (either from the System Engineer application or by switching the device off then on again). The associated Sleep Time parameter allows the amplifier to automatically go into Sleep mode if no audio signal has been detected for a period of time. This function can be defeated by setting the latter control to Manual.

## External Breaker Protection (EBP)

The Power (“PWR”) utility page provides access to the External Breaker Protection (EBP) feature, which allows the output power to be limited in order to prevent the nuisance tripping of mains circuit breakers or fuses when the amplifier needs to be operated on a mains supply with restricted capacity. Set the EBP value to that of the circuit breaker or fuse to which the amplifier is connected.

## Ethernet

### Ethernet configurations

IP addressing in the Device can be completely automatic; No setup is required.

When first installing and launching System Engineer, the computer Firewall may ask to allow System Engineer to access the network. **NOTE: This must be allowed for both private and public networks.**

### DHCP

There are two primary IP address ranges – one used when there is a DHCP server, and another (‘Link Local’) where there is no DHCP server (so the Device and the Computer will instead use ‘Auto IP’ to allocate themselves an IP address). Both the device and the computer must be in the same IP address range. In a local network environment such as an office where there is a DHCP server, both the computer and the Device will be in the DHCP IP address range, and so will connect immediately.



## AUTO-IP

The device will initially search for a DHCP server when first switched on (during which time its Online Indicator will be flashing). As it can take up to one minute to establish that there is no DHCP server available, this is the time it may take before Auto IP is entered.

Please be aware that it can also take some time from a computer being switched on in an isolated network (without a DHCP server), or unplugged from a network with DHCP to time out of DHCP searching, so it will not connect immediately to amplifiers that are already using Auto IP. The time it takes before it decides to revert to Auto IP depends on the operating system but it can take several minutes to acquire an Auto IP address.

## Static-IP

If the device or the computer has a static IP address set, System Engineer may not be able to 'see' the device if it is in a different IP Address range (i.e. in a different *subnet*). ***Unless there are good reasons it is best to avoid the use of static IP addressing if at all possible.***

## IP Troubleshooting

If System Engineer cannot connect to the device:

- A Router acting as a DHCP server is highly recommended as this provides the most trouble-free way of administering IP addresses. Always switch on any DHCP server before connecting either the computer or Amplifier to the network.
- If not using a DHCP server, check that the Current IP address in the device is compatible with the IP address of the computer. Generally, the leftmost two sets of 3 digits should be the same.
- If there is no Router in the system acting as a DHCP server, wait 10 minutes (for the computer to acquire the correct IP address) and try again.
- Check that the Firewall in the computer will allow System Engineer access to the network ***for both private and public networks***. Please refer to the Help feature in the System Engineer application for further guidance on this

## Snapshots

A Snapshot may be recalled either via the device User Interface, from the System Engineer application or via the AUX port on the rear of the Device.

The snapshot menu is accessed via the utility pages. Recalling a Snapshot triggers the recalling of a Component to each input and output, and may change other device-wide settings, effectively recalling a processor-wide preset. In addition to being able to recall snapshots from System Engineer and from the Device's front panel, some of the snapshots are also recallable from the auxiliary port.

Also see [Aux Port](#)

The parameters inside the Drive Modules are not individually stored in Snapshots. Recalling a Snapshot will merely trigger the recall of the appropriate Input and Output Components, rather than restoring the parameters that were active when the Snapshot was stored. This has the distinct advantage that the library of OEM presets may be updated without having to be concerned about what parameters might have been saved in users Snapshots. It does however require that any existing edits to the parameters in Drive Modules are stored into Drive Module presets before a Snapshot is stored.

Also see [Overview Of Modules Components and Snapshots](#)

## AUX Port

The AUX has two inputs, X & Y. These allow simple contact closure devices (relays or switches) or external logic signals to change the state of the amplifier as described below. Connecting an AUX input to ground (the earth symbol) will trigger it; there is no requirement for an external voltage. However, the ports can also be triggered directly by a logic signal as long as the logic 'low' goes below +0.5V. *Do not connect systems if their logic 'high' voltage exceeds +24V.*

The AUX port may be configured to work in a number of ways by adjusting the Style parameter in the Aux page of the [Utility menu](#):

- **None** - No operation
- **2+Mute** (Event or State) – Either Snapshot 1 or Snapshot 2 may be recalled by applying a *momentary* or *static* connection to an Aux port terminal, or the device may be muted by Grounding both Aux port terminals
- **3 Snaps** (Event or State) – Either Snapshot 1 or 2 or 3 may be recalled by applying a *momentary* or *static* connection pattern to an Aux port terminals
- **4 Snaps** (State) – One of the four Snapshots 1,2,3,4 may be selected by applying a *static* connection pattern to the Aux port terminals
- **3+Mute** (State) - One of the three Snapshots 1,2,3 may be selected by applying a *static* connection pattern to the Aux port terminals, or the device may be muted by Grounding both Aux port terminals
- **3+Sleep** (State) - One of three Snapshots 1,2,3 may be selected by applying a *static* connection pattern to the Aux port terminals, or the device placed in Sleep by Grounding both Aux port terminals
- **Mute+Sleep** (State) - The device may be muted by grounding Aux X or placed in Sleep by grounding Aux Y

This table shows the action taken for various Aux connection patterns in the various Aux port modes:

AUX X	AUX Y	2+Mute (State or Event)	3 Snaps (State or Event)	4 Snaps (State)	3+Mute (State)	3+Sleep (State)	Mute+Sleep (State)
Open	Open	No Change	No Change	Recall Snap 1	Recall Snap 1	Recall Snap 1	No Change
Gnd	Open	Recall Snap 1	Recall Snap 1	Recall Snap 2	Recall Snap 2	Recall Snap 2	Mute
Open	Gnd	Recall Snap 2	Recall Snap 2	Recall Snap 3	Recall Snap 3	Recall Snap 3	Sleep
Gnd	Gnd	Mute	Recall Snap 3	Recall Snap 4	Mute	Sleep	Sleep

Some of the above modes allow the AUX Port to be used either in *Event* mode (whereby a momentary push-button or momentary relay contact closure on one of the AUX lines will cause a Snapshot to be recalled). Or in *State* mode (where a rotary switch etc. connected to both of the AUX lines selects which Snapshot to use). Some of the other modes only allow *State* mode, requiring the connection pattern to persist in order for the Snapshot to be held as the current one.

**NOTE:** That if the contact closure port is being driven, or if the Aux Style is set to one of the *State* modes, this will override the snapshot recall setting in the menu (or in System Engineer). Also under these conditions, the snapshot menu items are not accessible, and the Home screen will show the Snapshot number as a reminder. Also see [Snapshots](#).

## Latency delay

All Digital Signal Processing, and conversion between different formats of signal – analogue/digital/network etc., necessarily introduce some delay (latency) to the signal path. Of course, we strive to minimise these latencies. Small as they are, it is sometimes useful to know their precise values. The following describes the principal latencies introduced by various parts of the Device:

### Input/Output Latencies

	Analogue Input	0.385ms
OR	Digital input at 96KHz sample rate	0.5ms
OR	Digital input at 48KHz sample rate	0.66ms
	Analogue Output	0.402ms
OR	AES3 Output	0.1ms
OR	Dante Output	1.29ms @44.1kHz
	(Excluding Dante network latency)	0.68ms @48kHz
		0.45ms @96kHz

### Processing Latencies (limited to a minimum of 1.57ms):

	Input HiShelf FIR	0.4ms (0ms if set to 'Off')
	LIR Linear Phase crossover	1.19ms/Fhp(kHz), limited to 30ms maximum **
	VxLim Limiter (VX mode off)	0.12ms/Fhp(kHz), limited to 1.57ms maximum **
OR	VxLim Limiter (VX mode on)	0.358ms/Fsplit(kHz), limited to 1.57ms max ††

Where Fhp is the High-Pass crossover frequency

\*\* This latency figure is calculated using the crossover High-pass frequency (in kHz)

†† This latency figure is calculated using the Vx Split frequency (in kHz)

**Important tip:** The processing latency is constant at 1.57ms unless LIR crossover filters or FIR HiShelf EQs are used, so normally you would just need to add the Input and Output delays to this constant value.

If LIR or FIR are in use, the Processing latency of a Drive Module may increase beyond this figure. The Drive Module Latency may be viewed on the Latency page of the relevant Input DSP channel. This can be accessed by pressing Input then down until the latency page is reached.

When LIR, is used the Vx Limiter can take the overall latency above the 1.57ms. When high pass frequency is set below 40Hz the filter will automatically revert to Linkwitz riley, this is set so that the latency will not exceed 30ms as stated.

**Note that the latency reported on the Latency screen in the utilities menu does not include the Input/Output latencies.**

**When using input FIR filters, LIR or VX Limiters always check the view latency screen to see the latency attributed to that Drive Module.**

Example:

<b>Input/Output</b>	
Analogue Input	0.385ms
Analogue Output	0.402ms
<b>Processing</b>	
Input HiShelf FIR (Off)	0ms
LIR Linear Phase crossover (500Hz)	2.38ms
VxLim Lim (VX mode on, 1KHz Fsplit)	0.358ms
Total	<b>3.525ms</b>

Note that the latencies within a Drive Module are equalised among outputs of that Drive Module. That is, padding delay will be automatically added to some outputs such that the total latency is the same in each output of a Drive Module. On models which have Output FIR filters, these may declare latency which will also be compensated for.

This latency equalisation does not extend outside a Drive Module, so Drive Modules are not guaranteed to have the same latency as one-another.

## **Secure Mode**

When activated, this will disable all the front panel controls so they cannot affect the signal path, making the unit secure against tampering. The only option that is left for user control is snapshot recall. If this is not required then storing the same device state in every snapshot will effectively disable this feature. When in secure mode, the indicators still operate normally. To activate secure mode, press and hold the utility button for 5 seconds. To deactivate, press and hold the utility button for 5 seconds. When in secure mode, this will be shown on the display. Note that the Ethernet communications port is still active in secure mode.

## **Overlay Flush**

If the device has been used in Module Groups, and still has an active Overlay (as indicated by the Overlay indicator), these can be removed by simultaneously pressing and holding for 5 seconds the Utility and Enter buttons. See [Overlays](#).

## **Revert to Factory Settings**

If you wish to erase all of your settings in the device and revert everything to factory settings, then simultaneously press and hold for 5 seconds the Up button and the Mute 1 button, then follow the prompts on the display. Only continue by pressing the Enter button if you are sure this is what you want to do. Otherwise, press the Down button to escape. Alternatively, you can access this feature from System Engineer application using the 'Hamburger' button on the bottom-right of the device control panel, selecting 'revert to factory settings'.

## **Protection Systems**

Comprehensive protection features preserve the longevity of the loudspeaker and amplifier by continuously monitoring several critical parameters, and reducing the gain, or muting the amplifier either temporarily or permanently depending on the nature and seriousness of the fault or misuse. The amplifier will recover and restart if at all possible, but may remain in shut down if a serious fault persists.

Limiters deal with routine over-driving of the amplifier, making sure that the driver(s) are not pushed too hard. The limiter indicators will warn you when the driver is being driven into limit.

Minor faults are dealt with by 'dimming' the amplifier, reducing the level to a sufficient degree and for a sufficient time that the amplifier is able to recover gracefully without any user interaction. When the fault condition has passed, the amplifier will recover automatically.

When the protection systems are reducing the level, this is indicated by illuminating the left-hand Amplifier channel protection indicator. This will also illuminate when the output voltage is 'clipping'. This indicator will remain permanently illuminated if the channel has been muted by the protection systems. The Mute button will also flash. This will usually also be indicated by a warning message on the display.

Some types of protection affect all output channels, so you may see the Amplifier indicator illuminated, and the Mute button flash, on every channel.

### Summary of Protection Indication

The reasons for the protection indicators illuminating are summarised as follows:

Amplifier Indicator	Driver Indicator	Notes
	Limiter 6dB over	
	Thermal limiting	
	Excursion limiting	
Amplifier clipping		
Amplifier clip limiting		
Amplifier Current limiting		
Amplifier VHF limiting		
PSU Current limiting		Will show on all output channels
PSU Power limiting		Will show on all output channels
Thermal limiting		Will show on all output channels

### Incident Reporting

In the System Engineer application, a coloured indicator appears on a Device Bar in the System View which displays the Incident state of the device. The Incident state may be one of three states:

- Red: Fault (The device is faulty in some way and requires attention)
- Yellow: Check (The device may not be performing to its full and should be checked)
- Green: OK (The device is performing well and requires no attention)

Holding your mouse over the Incident indicator for a few seconds will show the current incident level and name.

If an incident is reported you can disable it, and all less serious incidents, by right clicking the bar in System View and selecting 'Enable/Disable Alarms'. Doing this will show a cross over the Incident indicator and the device will no longer report any Incidents at this level or below.

If any Incidents have previously been disabled they can be enabled by using the right click context menu and selecting 'Enable/Disable Alarms' again.

Any active incident will be shown on the display of the device.

A Fault state will also cause the Fault Relay to open. See [Fault Relay](#)

### Fault Relay

Three connections are available via the Phoenix connector for this relay. The schematic representation printed on the rear panel shows the 'idle' state of the relay (when the amplifier is not switched on). When the amplifier is switched on, the relay will normally energise. When a Fault incident occurs, the relay will be de-energised. This will allow either a Fault Incident or a loss of power to be seen as a 'Fault'.

Also see [Incident Reporting](#)

## Performance Logging

The System Engineer application allows you to inspect various performance measurements, including various graphs of performance against time, recording events over a period of up to three days. Since the amplifier cannot record any events whilst powered-off, breaks in a log due to power-downs are indicated by a break symbol || in the log.

The events recorded are:

**Supply Current** - How much current is being supplied to the device via the mains inlet

**DC Link Voltage** – A voltage which is derived from the mains supply voltage

**Thermal Capacity** – How much of the available thermal capacity has been used

**Driver Current** (for each output) – The average current being delivered to the driver

**Driver Impedance** (for each output) – The average impedance of the driver

**Protection Limiting** (for each output) - How much the amplifier is 'dimming' itself in order to protect itself from potential damage

The data in the log can be exported by right-clicking on the log to launch a context menu, and selecting "copy log data to clipboard". The data could then be pasted into a spreadsheet for further analysis. Your dealer may ask you to do this if you have experienced a problem.

Alternatively, all of the operational and performance data, including the logs may be collected together into a single file by selecting File > Save Device Diagnostics. Your dealer will be able to read and interpret this data.

## Tipi Third Party Interface

Whilst the device can be set up and controlled entirely from the front panel, or by using a dedicated control panel in the System Engineer PC application, Tipi provides a powerful yet very simple means of controlling the device using ASCII strings from a very wide range of controller devices. The Tipi protocol uses TCP/IP on the Ethernet interface. For a full list of Tipi command strings and settings, please refer to the Tipi Protocol document.

# Processing Block Diagram

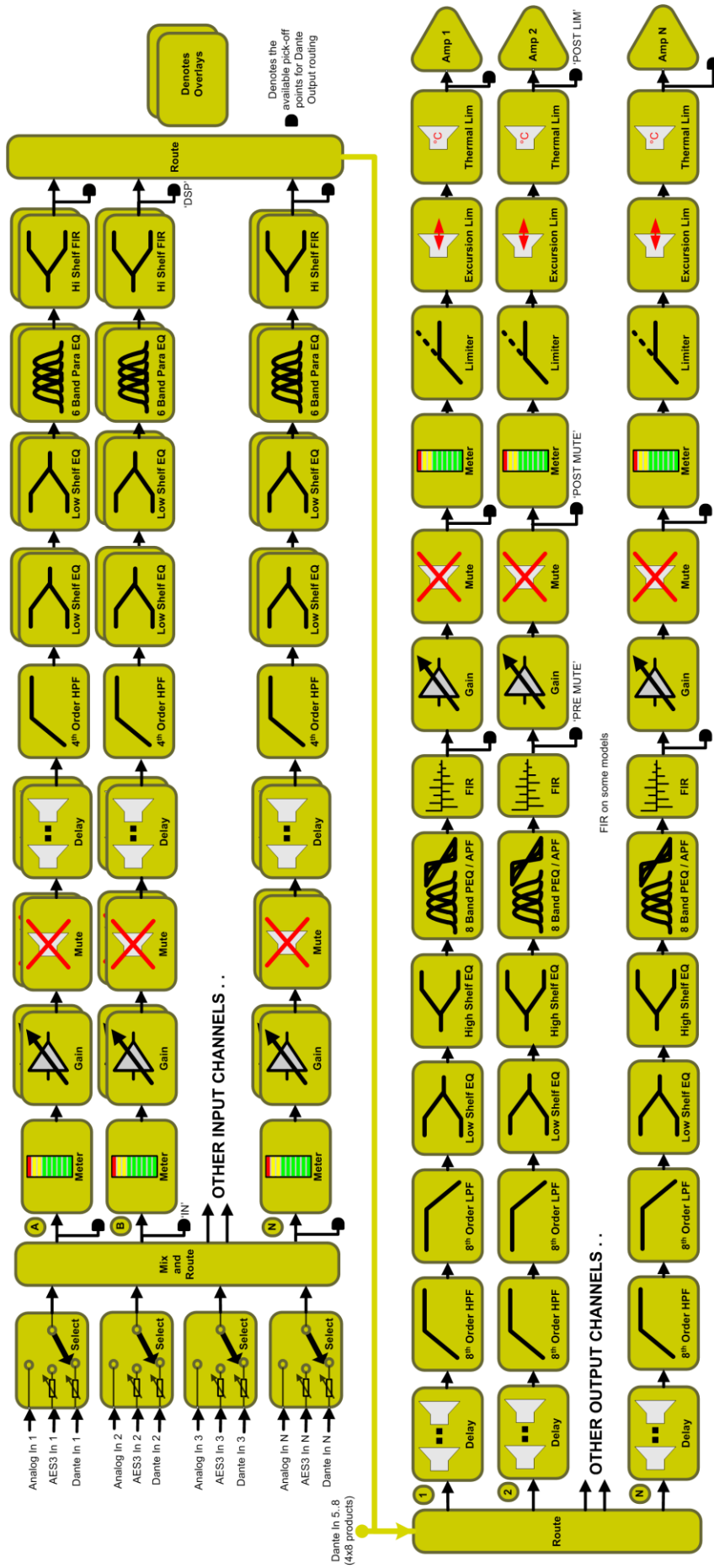

Input Menu Map

Utility Menu Map

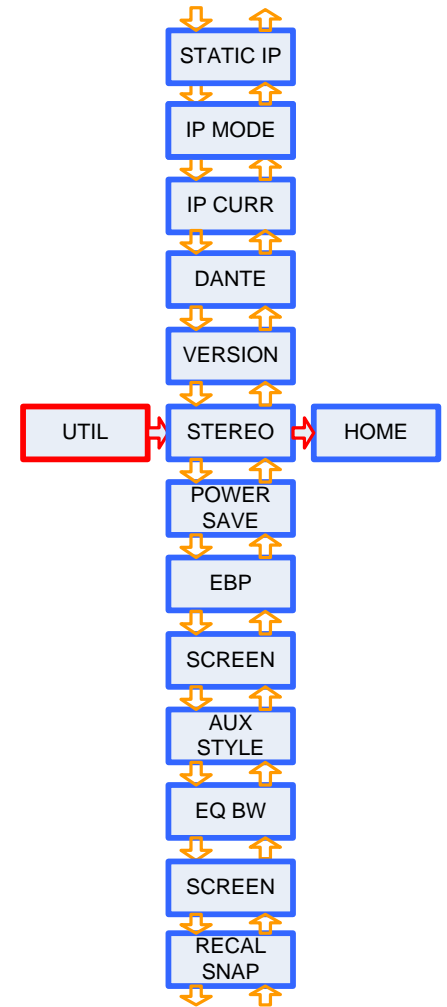

KEY

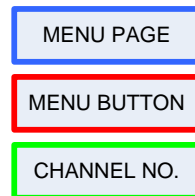

↕↕ UP/DOWN BUTTON PRESS

⇒ MENU BUTTON PRESS



# Output Menu Map

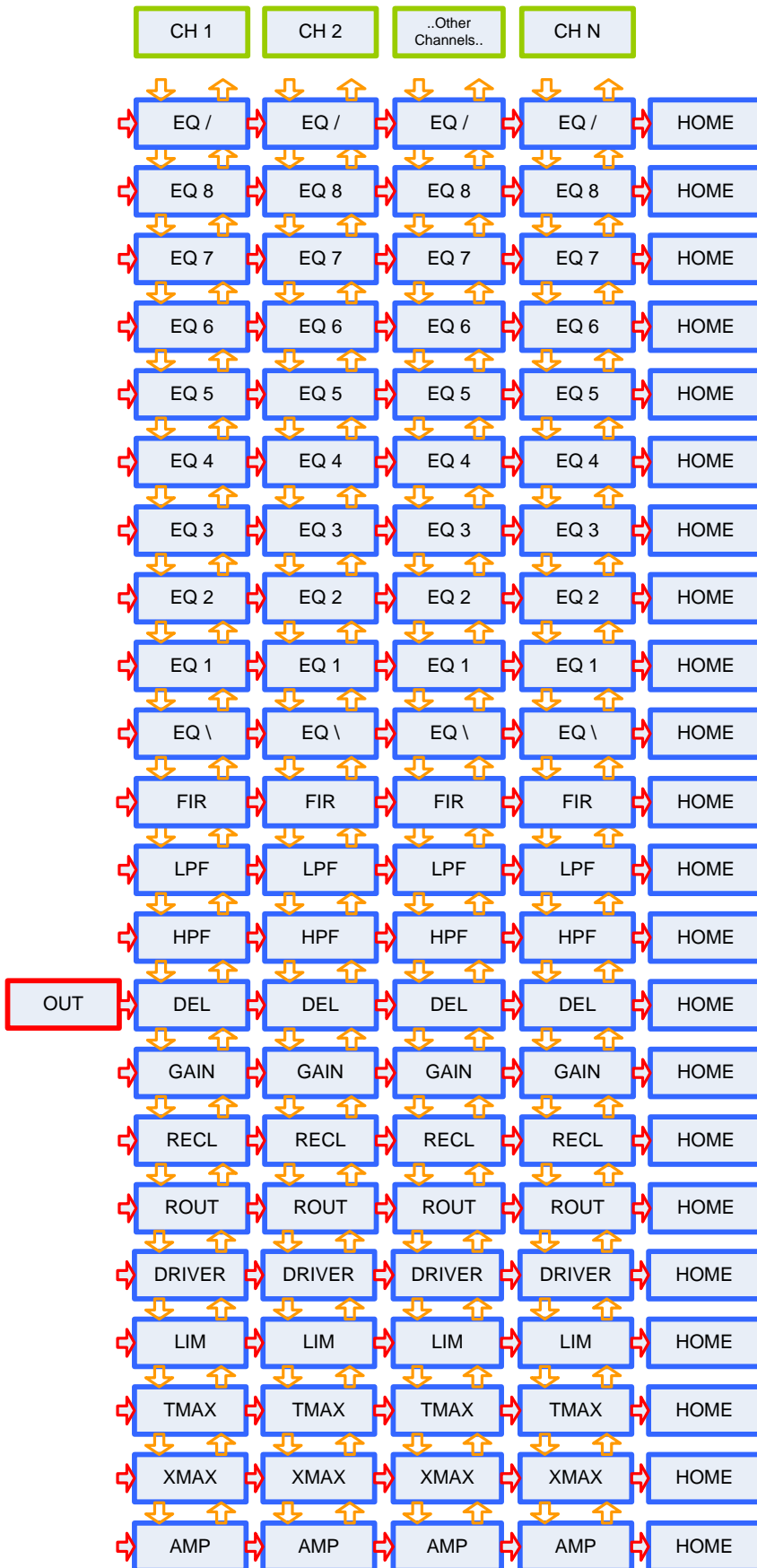

## EQ and Filter Response Graphs

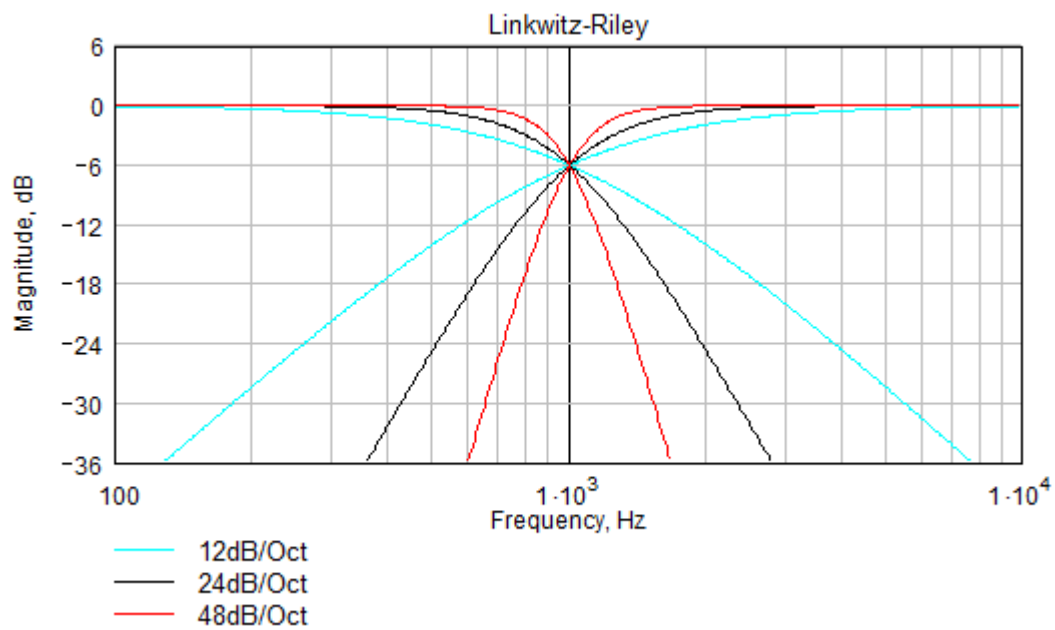
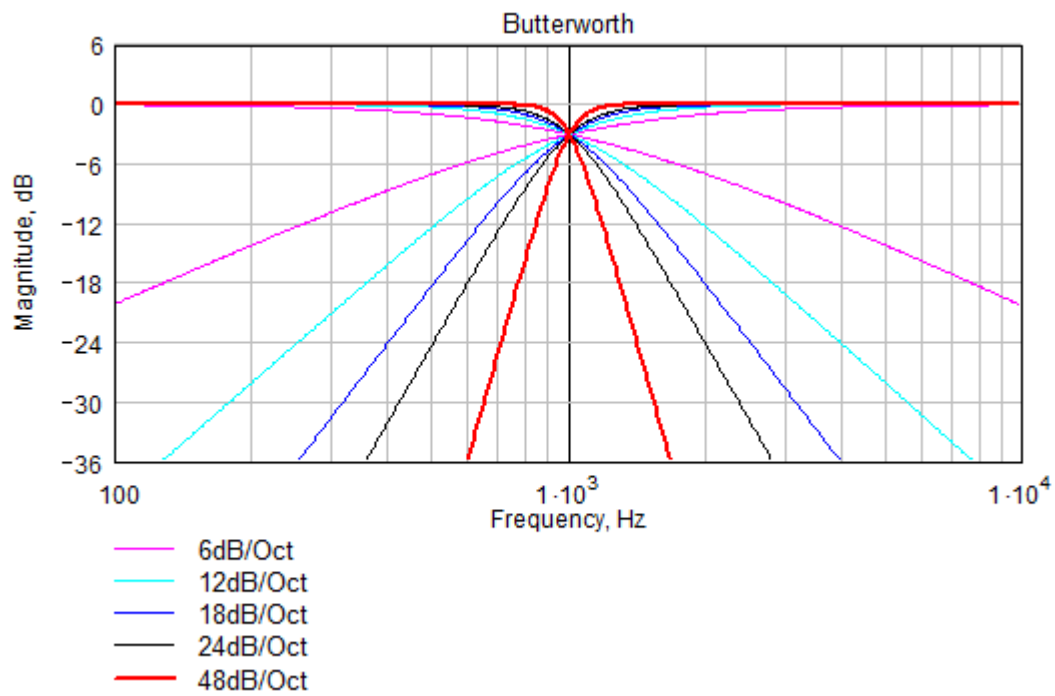

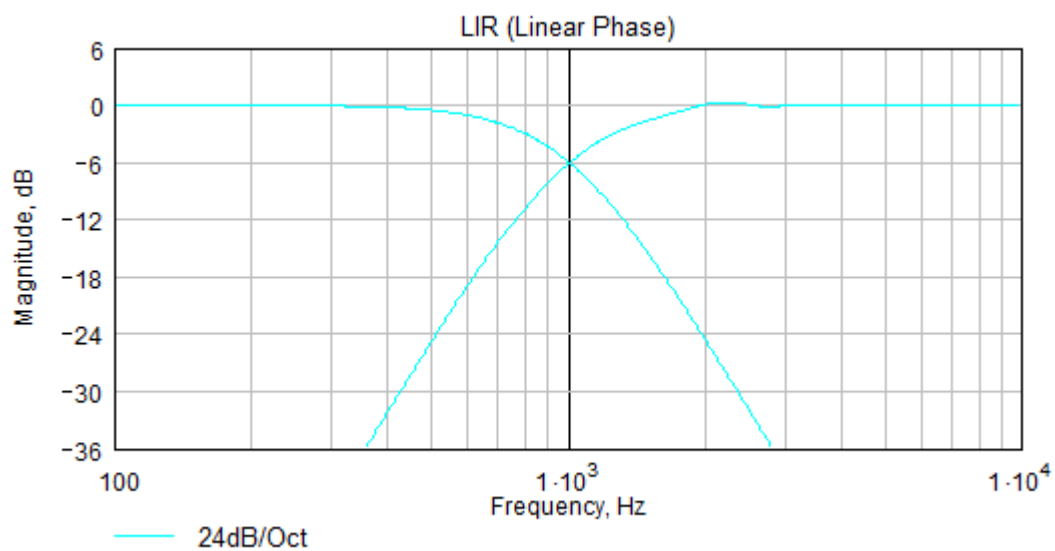
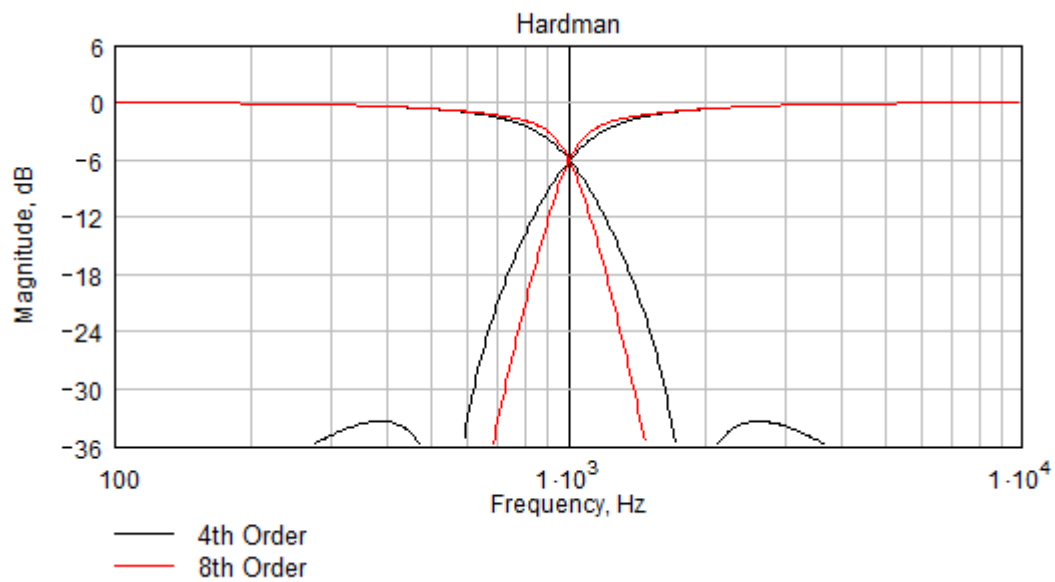
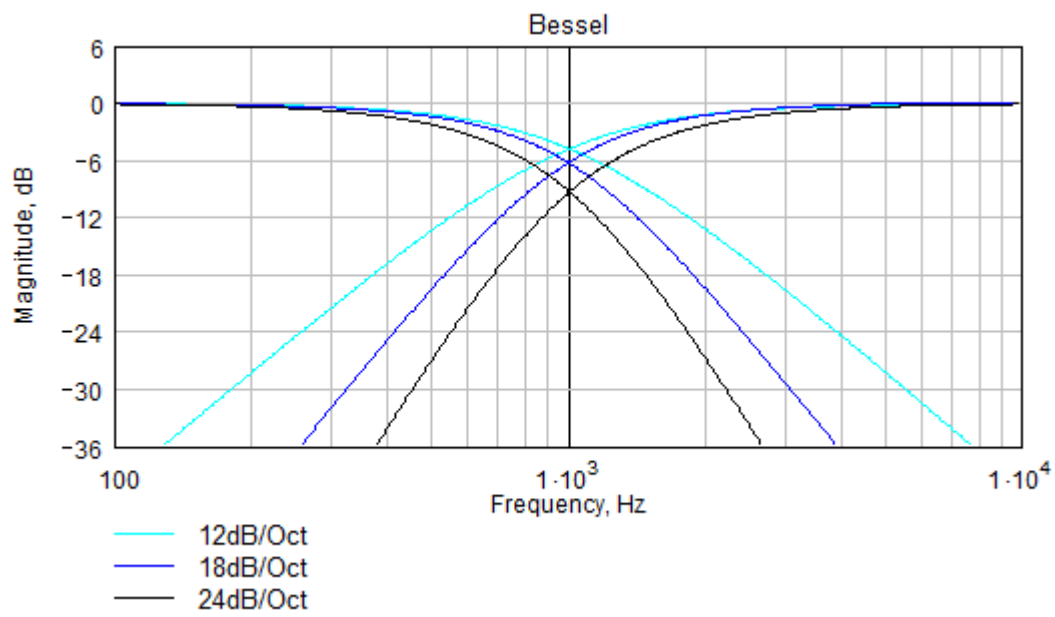

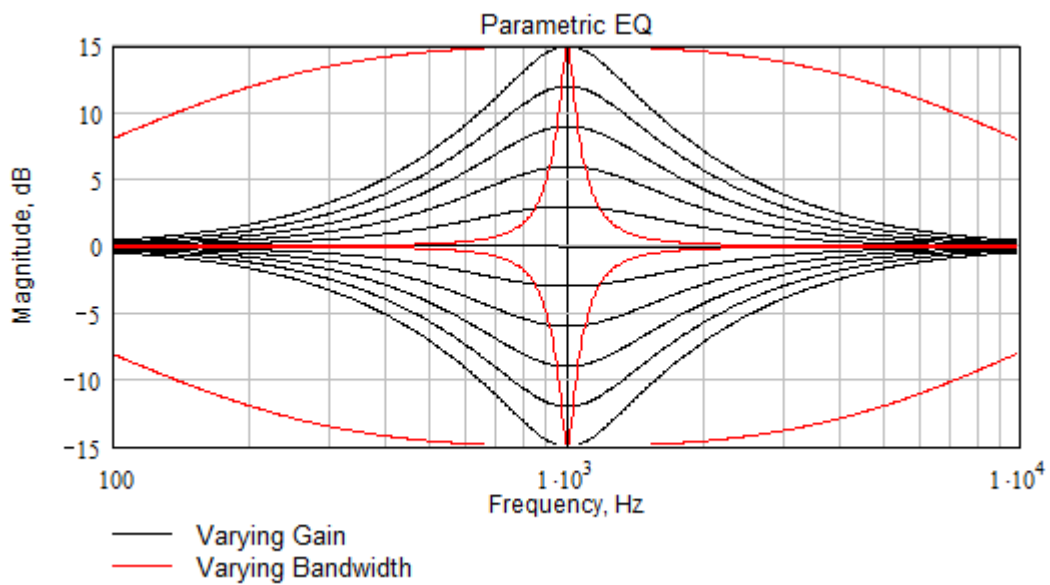
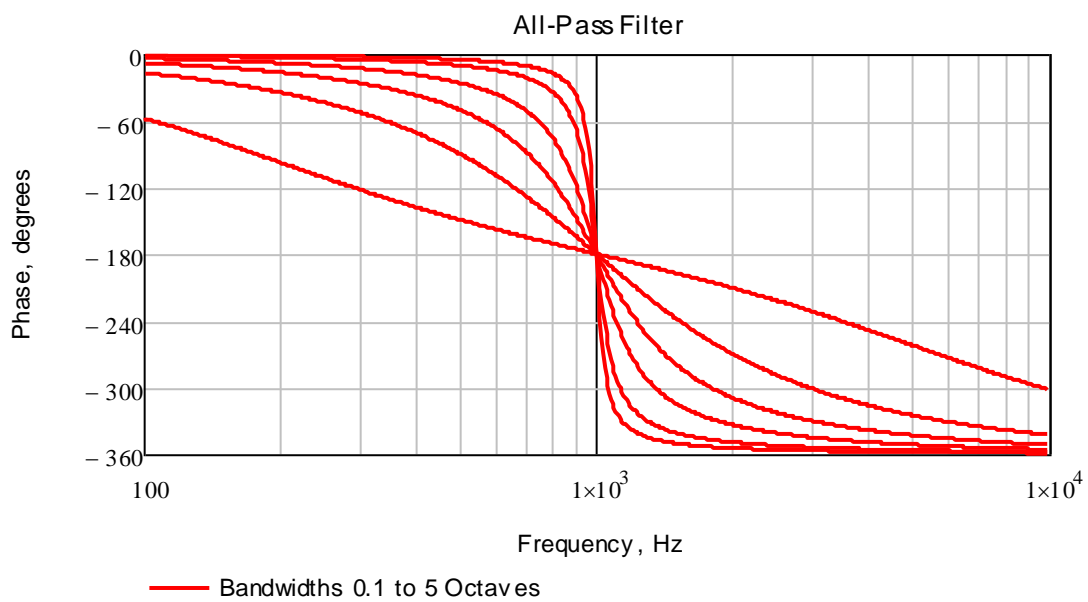

## Technical Specifications

---

### General

Number of Output channels	Four (44M) or Eight (48M)
Total power output (44M)	20,000/10,000/6,000 Watts RMS (44M20, 44M10, 44M06)
Total power output (48M)	20,000/10,000/6,000/3,000 Watts RMS (48M20, 48M10, 48M06, 48M03)
Input types	Analog, AES3, (Dante option, AES67 compatible)
Control, monitoring & alarm	Ethernet, configurable function Volt-free relay and contact closure port
Energy saving modes	Standby and deep sleep, both with auto-sleep timers
System sleep and wakeup	Front panel switch, network command, contact closure and audio detection
Max ambient temperature (full power, no limiting)	40degC (105degF)

### Audio

Amplifier topology	Proprietary 5th generation Linea Research Class D.
Amplifier modulation scheme	Low feedback, multiple loop, with feedforward error correction.
Dynamic range (analog input to speaker output)	>113dBA typ.
Dynamic range (AES3 or Dante input to output)	>114dBA typ.
Frequency response	<7Hz to >30kHz, 4 Ohms, -2.5dB. (Note 1)
Total harmonic distortion, THD	<0.05% typ, 1kHz, AES17, 4 Ohms.
Inter-channel crosstalk (worst combination of channels)	better than -85dBr at 1kHz. better than -75dBr at 10kHz.
Slew Rate	>60V per microsecond typical
Damping factor (Ref 8 Ohms)	>800 at amplifier output (see Linea's "Damping factor debunked" whitepaper)
Maximum analog input level	+20dBu.
Analog input sensitivity range for full output	0dBu to +20dBu, continuously adjustable.
Analog input	20k Ohm, electronically balanced.
Analog link	Directly connected to the analog input.
Analog ground scheme	AES48 standard compliant.
AES3 input	Transformer isolated
AES3 link	Actively regenerated with automatic direct bypass to the AES3 input if the unit is unpowered. Do not 'daisy-chain' more than 8 amplifiers from a single AES3 source
AES3 supported sampling rates	24kHz to 192kHz (auto locking).

Note 1: On 8-output models, the frequency response reduces to 23kHz on outputs which have FIR enabled.

### Digital processing

Resolution	40 bit, using proprietary LMD (Linea-Micro-Detail) algorithms.
Sample rate	96kHz.

### Special functionality:

Class leading limiter suite	See the 'speaker protection systems' section.
Hardman crossover filters	Better out of band rejection than Linkwitz-Riley (Unique to Linea).
LIR crossover filters	Linear Phase without the compromises of FIR filters (Unique to Linea).
FIR Shelving EQ filters	For linear phase filtering.
FIR Output filters	For equalisation or crossovers with linear/arbitrary phase (on some models).
Overlays	Twelve additional independent overlays of EQ, Delay and Gain.

## Power Output

Model	44 series M20	44 series M10	44 series M06
Power specification	RMS output power per channel, all channels driven with continuous program material and a nominal ambient temperature of 40degC / 105degF		
Crest Factor of 4 (12dB), 2-Ohm nominal load	5,000W	2,500W	1,500W
Crest Factor of 2.8 (9dB), 4-Ohm nominal load	3,000W	2,500W	1,500W
Crest Factor of 2 (6dB), 8-Ohm nominal load	1,500W	1,500W	1,500W (when set correctly)
Bridged, per channel pair, 4 Ohm load	10,000W	5,000W	3,000W
25V line (CV) operation, Crest Factor 4 (12dB)	1250W	885W	685W
70V line (CV) operation, Crest Factor 4 (12dB)	3500W	2,500W	1,500W
100V line (CV) operation, Crest Factor 4 (12dB)	5,000W	2,500W	1,500W

Model	48 series M20	48 series M10	48 series M06	48 series M03
Power specification	RMS output power per channel, all channels driven with continuous program material and a nominal ambient temperature of 40degC / 105degF			
Crest Factor of 4 (12dB), 2-Ohm nominal load	1,500W	1,250W	750W	400W
Crest Factor of 2.8 (9dB), 4-Ohm nominal load	2,500W	1,250W	750W	400W
Crest Factor of 2 (6dB), 8-Ohm nominal load	1,500W	1,250W	750W	400W
Bridged, per channel pair, 4 Ohm load	3,000W	2,500W	1,500W	800W
25V line (CV) operation, Crest Factor 4 (12dB)	685W	625W	485W	355W
70V line (CV) operation, Crest Factor 4 (12dB)	1,935W	1,250W	750W	400W
100V line (CV) operation, Crest Factor 4 (12dB)	2,500W	1,250W	750W	400W

## Power supply

Topology (main power supply)	3rd generation Series Resonant.
Topology (auxiliary and standby supplies)	Low quiescent Eco-Flyback.
Internally stored energy	>600 Joules.
Mains input voltage range (automatically configured)	85V to 240V.
Mains input frequency range	47Hz to 63Hz.
Mains inrush current (max for <10ms)	6A at 115V, 12A at 230V.

## Protection systems

Note : Under all circumstances the control and protection systems will endeavor to deliver the maximum power possible for a given set of conditions, applying limiters only in extreme circumstances. Muting will only occur when a dangerous situation is detected, normal operation automatically resuming when the condition clears.

## System protection

Excessive output current  
Excessive power supply current

Excessive amplifier section temperature

Excessive power supply section temperature

Excessive DSP section temperature

Mains voltage out of range

Fan speeds out of range

Internal power rails out of range

## Speaker protection

Audio soft-clip limiter

VxLim, Multiband peak limiter  
(Unique to Linea)

VxMax, Multiband overshoot limiter  
(Unique to Linea)

Vx-Xmax, Driver excursion limiter

Vx-Tmax, Driver thermal limiter  
(long term power limiter)

DC offset protection

Excessive HF energy (VHF) limiter

## Power distribution protection systems

Mains inrush current limiting (soft start and anti-surge).

Mains average current limiting (mains breaker / fuse trip protection).

Randomised initialisation when powered up to reduce the peak power demand in large systems.

## Monitoring and logging

Supply current logged vs time

Supply voltage logged vs time

Thermal Capacity logged vs time

Each driver current logged vs time

Each driver impedance logged vs time

Protection limiting for each output logged vs time

Number of power cycles counted

Number of mains brownout events counted

Fan speeds continuously monitored

Fan underspeed events counted

Various protection mute events counted

Driver Impedance continuously monitored

An inbuilt alarm and notification system can be configured to indicate problems to remote devices either via the network or the Volt-free changeover relay contacts accessibly on the rear panel.

## OEM Features

Most parameters may be individually hidden (OEM locked) from the user with access being password protected.

## Physical

Cooling

Airflow

Air filtration

Variable speed fans.

Front to back.

Washable media, changeable without the use of tools.

Analog IN and LINK connectors

AES3 IN and LINK connectors

Audio output connector

Mains input connector

Dante Primary and Secondary

Relay output & contact closure inputs

Front panel display (backlit)

Front panel encoders

Front panel push buttons

Genuine Neutrik XLR.

Genuine Neutrik XLR.

Genuine Neutrik Speakon.

Genuine Neutrik 32A Powercon.

Shielded RJ45.

Phoenix pluggable terminal block.

Graphical, high contrast, daylight visible.

Two, indented, velocity sensitive.

Large, tactile, illuminated.

LED indicators	Bright, easily differentiated. Enclosure Standard 19" 2U (88mm) with handles and optional rear support system
Relay contacts	Can switch between 10uA and 1A at up to 30V
Net Weight	12.5kg (27.5 pounds).

## Options

---

There is internal provision for digital audio network option cards to be factory fitted. Currently Linea Research support Dante from Audinate (AES67 compatible).

Rear rack support kit (part number ZA1182).