



OPTIMISED LINE ARRAYS WITH SCALABLE RESOLUTION



WAVEFRONT
PRECISION

WPM
WPS
WPC

Unite Your Audience
The Martin Audio Experience



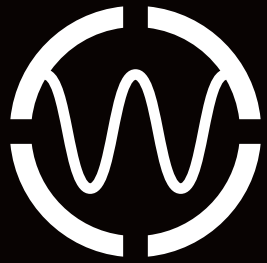

WAVEFRONT PRECISION

In recent years, Martin Audio's award-winning MLA systems have raised the expectations of audiences, sound engineers and promoters worldwide. With independent drive of individual acoustic cells controlled by industry-leading DISPLAY™ optimisation software, MLA technology delivers unmatched sound quality and coverage consistency while reducing sound-spill.

Drawing on the research and technology behind MLA, the Wavefront Precision Series is a new generation of multi-purpose line arrays designed to bring Martin Audio's legendary sound, coverage consistency and control to a broader range of touring applications, installations and budgets. Comprising WPM, WPS and WPC, Wavefront Precision line arrays are designed as complete systems with external iKON® multi-channel amplifiers and optimised by automated DISPLAY software. Their bigger brother, WPL, is also available and information on this product can be found in its own dedicated brochure.

Adopting the principle of scalable resolution, with external, dedicated multi-channel amplifiers, Wavefront Precision line arrays are uniquely flexible, upgradeable and financially accessible.





 WPM



 WPS



 WPC



iKON[®]

SCALABLE RESOLUTION

With exceptional line array performance guaranteed by the acoustic design itself, scalable resolution unlocks the full potential of a Wavefront Precision array and provides an adaptable pathway into the world of advanced optimisation.

The greater the resolution of the array in terms of individually driven enclosures, the more precisely DISPLAY can fine-tune audience coverage and hold the frequency response and SPL's throughout the venue within a tight window specified by the user.

For the first time in the marketplace the decision on the level of resolution and control that is right for the install, client, event or budget is yours.

With scalable resolution, the commercial advantages are clear:

- Design systems to better suit project budget targets.
- Ability to increase resolution over time by buying more amps at later stage.
- Dynamic deployment within a venue or site where the main PA could be driven by enclosures with more dedicated amp channels than may be necessary for delays.
- Adaptable rental pricing based on event dynamics and clients' resources.

Wavefront Precision: Scalable resolution – the choice is yours

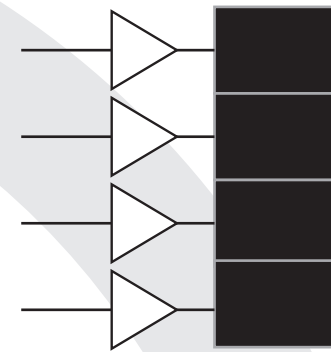

One Box Resolution

1 Top Box to 1 Amp Channel

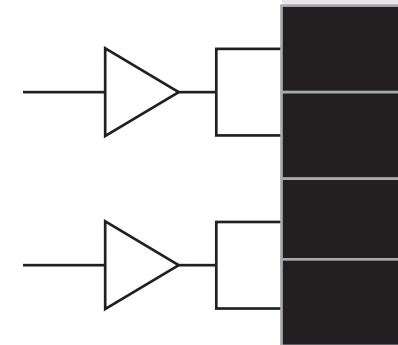

Two Box Resolution

2 Top Boxes to 1 Amp Channel

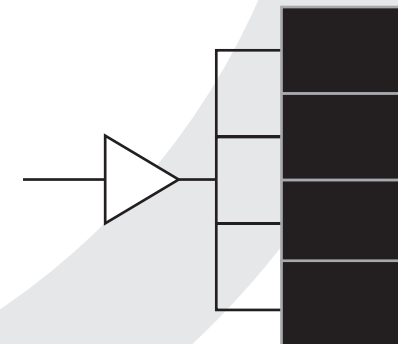

Four Box Resolution

4 Top Boxes to 1 Amp Channel

INCREASING RESOLUTION

STANDARD LINE ARRAY RESULTS VS. SCALABLE RESOLUTION

Standard 8 box line array Vs WPM 8 box array with scalable resolution. Mic positions within venue. SPL and Frequency Response.

A. Standard Line Array

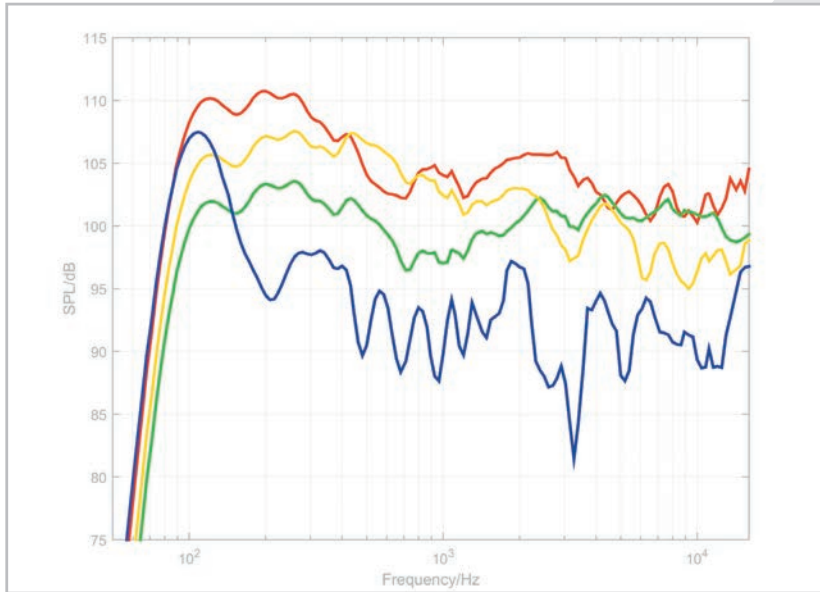

B. WPM – 4 Box Resolution

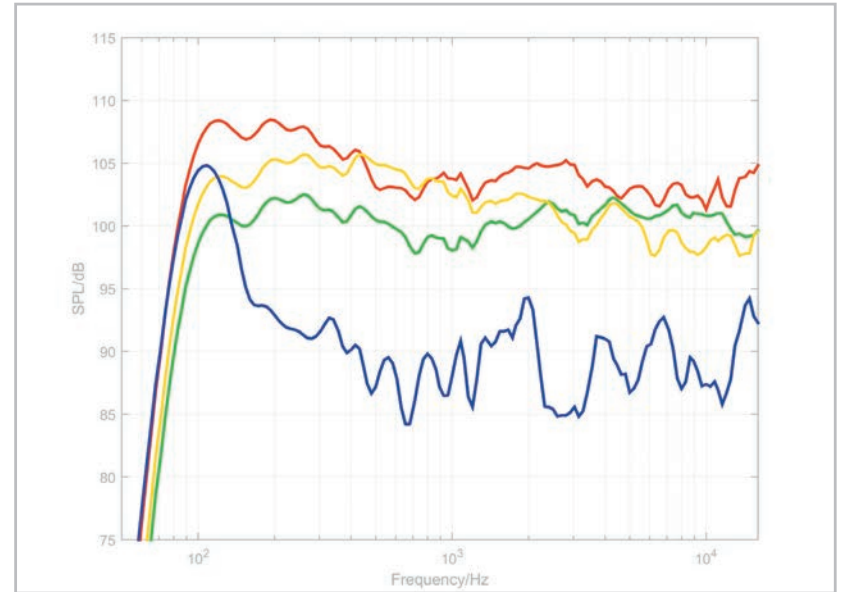

C. WPM – 2 Box Resolution

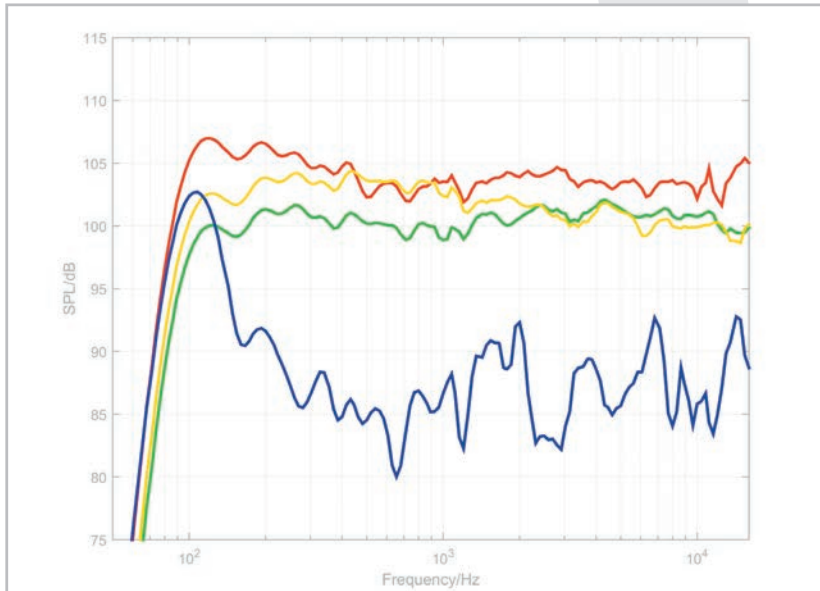

D. WPM – 1 Box Resolution

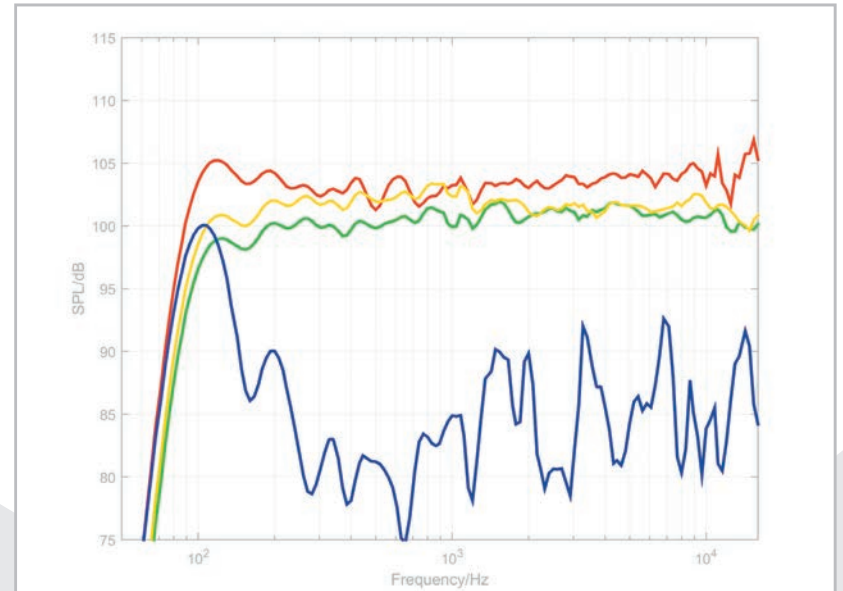

Rejection behind speaker

Front Row

Mix Position

Back row

DESIGN AND MATERIALS

It's not only the consistent coverage, flexibility and scalable resolution that set Wavefront Precision line arrays apart. Their exceptional sonic performance and exemplary horizontal pattern control are born from Martin Audio's trademark, innovative approach to high-efficiency acoustic design.

Wavefront Precision enclosures are constructed from plywood and finished in durable, easy-to-maintain textured paint, with fabric-backed protective steel grilles. Discreet side pocket handles and rear grips are provided to assist handling and splay-angle adjustment, while integrated three-point rigging systems assure efficient and safe construction of arrays of up to 16 enclosures.





• WPM



• WPS



• WPC

FEATURES

- Compact and ultra-compact line arrays
- Scalable resolution for advanced array control
- External, dedicated, multi-channel Class D amplification
- Industry-leading DISPLAY software interacts with DSP for highly-accurate results
- Fast, integral 3-point flying systems for up to 16 enclosures
- Side and rear handles for ease of handling and setting splay angles
- 100° horizontal constant directivity pattern control

BENEFITS

- Consistent coverage achieved 'straight-out-of-the-box'
- DISPLAY intelligent software reduces set-up time and eliminates trial-and-error
- Improved audience coverage with reduced sound-spill

APPLICATIONS

- Touring sound reinforcement for small and medium-size venues
- Fixed installations in concert halls, theatres, ballrooms and HoW
- Sports stadium and arena installations
- Corporate AV events



DISPLAY OPTIMISATION

DISPLAY is incredibly powerful. Based on an acoustic model accurate to within $\pm 1\text{dB}$ of measured data, it provides a virtual environment in which arrays can be configured and optimised and delivers unrivalled coverage consistency over the audience — right from switch-on. Also, by reducing sound impacting non-audience areas, rear walls and ceilings, the detrimental influence of the room can be significantly 'dialled-out' — increasing clarity and intelligibility in challenging acoustic environments.

DISPLAY leaves nothing to chance and takes the guesswork out of array design and deployment — generating predicted frequency responses throughout the venue and providing comprehensive rigging information, including mechanical safety analysis.

Array DSP parameters calculated by DISPLAY are easily uploaded to the iKON amplifiers via Ethernet, using Martin Audio's VU-NET™ real-time control and monitoring software.

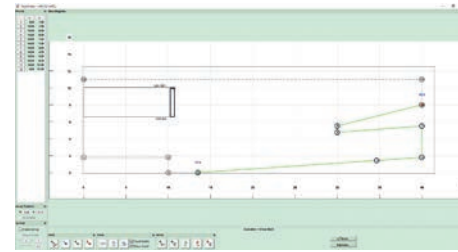

Step 1: Venue entry

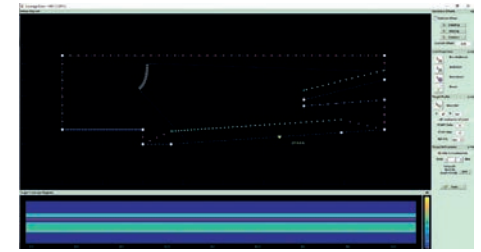

Step 2: Set coverage parameters

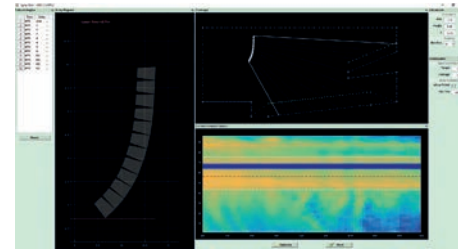

Step 3: Calculate splay angles

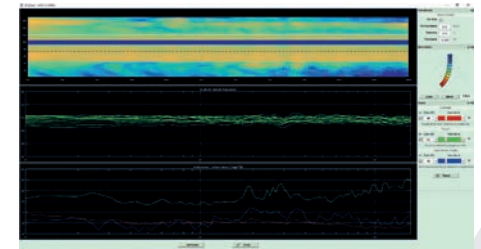

Step 4: Optimisation and upload



AMPLIFICATION, DSP AND NETWORKING

Wavefront Precision line arrays are designed as complete systems with dedicated, high-performance iKON multi-channel Class D amplifiers. Both the iK42 4-channel amplifier and iK81 8-channel amplifier are capable of very high power outputs and feature high-speed Ethernet communication for system control and monitoring via VU-NET, plus Dante™ digital audio networking. With the option to transmit digital audio over a single CAT5 cable, quality is maintained over long cable runs and integration with other devices in the sound system is straightforward.

Because the amplifiers are external to the loudspeaker enclosures, the resolution of the array can be increased as required by simply adding more amplifier channels to drive more array enclosures independently — increasing the level of control available to DISPLAY to fine-tune coverage and reduce room influence. External amplifiers also facilitate ease-of-servicing in fixed installations.

Both the iK42 and iK81 provide powerful DSP processing of up to 1000 FIR filter taps @ 48kHz on each output channel. This high number of taps is essential to implement DISPLAY'S wide bandwidth optimisation capabilities.

The complete system approach not only guarantees that Wavefront Precision arrays perform repeatedly and effortlessly to their design maximum, but also that they are compatible worldwide.

iK42/iK81 FEATURES

- Four/eight channels of Class D amplification
- Onboard DSP on all inputs and outputs
- FIR filtering on each output
- Switch mode, global voltage power supply
- 20,000 watts (iK42)/10,000 watts (iK81) total RMS output
- Intuitive front panel user interface
- Ethernet network for system operation and monitoring via VU-NET
- Analogue, AES3 and Dante™ digital network audio inputs
- Extensive protection and monitoring

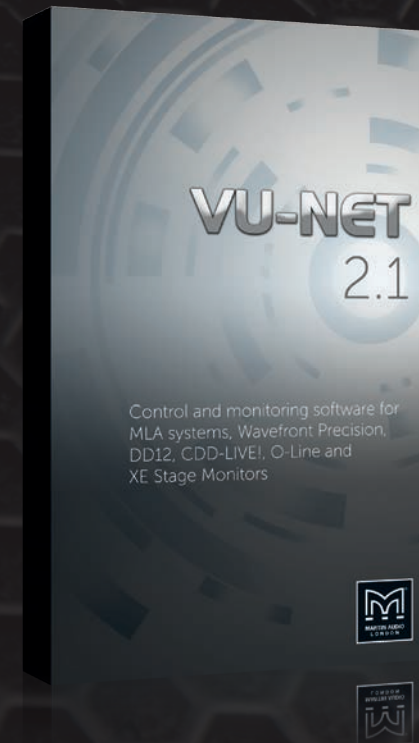

iKON



The scalable resolution of WPM offers greatly improved coverage consistency and control compared to a standard line array and provides a flexible pathway to advanced array optimisation.



WPM RESOLUTION MATRIX

	Benefits	Competitors	WPM
1 box Resolution Display Optimised	Hard Avoid® capability, high consistency, electronically adjustable coverage		✓
2 box Resolution Display Optimised	Significantly improved audience coverage consistency over splay angles only, offering a compelling performance & price ratio		✓
4 box Resolution Display Optimised	Improved audience coverage consistency over splay angles only		✓
Mechanical Optimisation via Display	Splay angles optimised using highly-accurate acoustic model; more consistent and faster than standard line array using basic geometric model		✓
Standard line array	Splay angles chosen by the user or calculated using basic geometric model	✓	✓

WPM is incredibly versatile. Its very small footprint and light weight make it the system of choice for smaller venues which require superb fidelity, coverage consistency and control from an ultra-compact line array. With a peak SPL of 130dB peak, it is also very powerful — a 12-box array will throw beyond 35 metres (115ft) and produce live music at high levels in up to 3000-seat venues. It embodies the very latest acoustic technology in an ultra-compact enclosure and is the ideal system for small-to-medium scale theatres and live music venues, AV events and installations in concert halls, ballrooms and HoW.

A passive 2-way system with an impedance of 16 ohms, it can be driven in blocks of 1, 2, 3 or 4 resolution configuration. With a complement of 2 x 6.5" (165mm) LF drivers and a vertical column of 3 x 1.4" (35mm) aluminium dome HF drivers, the acoustic design of WPM is uniquely innovative. The LF drivers are located in the side walls of the HF horn — an arrangement which would introduce acoustic cavities which would degrade the horizontal dispersion if conventional cone drivers were used. WPM's drivers adopt an elegant solution by having solid moulded diaphragms which match the contours of the horn walls and maintain the continuity of the horn profile. Each LF driver also features a demodulation ring in the neodymium motor system to minimize distortion and maximise mid-band output.

In the triple-driver HF section, each individual HF wavefront is precisely coupled to the horn throat via a short waveguide for faultless 100° horizontal constant directivity coverage.





The scalable resolution of WPS offers greatly improved coverage consistency and control compared to a standard line array and provides a flexible pathway to advanced array control.



WPS RESOLUTION MATRIX

	Benefits	Competitors	WPS
1-box Resolution Display Optimised	Hard Avoid® capability, improved audience consistency, electronically adjustable coverage		✓
2-box Resolution Display Optimised	Significantly improved audience coverage consistency over splay angles only, offering a compelling performance & price ratio		✓
3-box Resolution Display Optimised	Improved audience coverage consistency over mechanical optimisation		✓
Mechanical Optimisation via Display	Splay angles optimised using highly-accurate acoustic model; more consistent and faster than standard line array using basic geometric model		✓
Standard line array	Splay angles chosen by the user or calculated using basic geometric model	✓	✓

WPS is a versatile, state-of-the-art line array with a peak SPL of 133dB and is designed for small-to-medium scale touring and install applications that require a high output array with reduced weight and footprint. With exemplary coverage consistency and superb sound performance, the flexibility of WPS makes it an ideal system for live sound reinforcement and installations in theatres, concert halls and Houses of Worship. Return-on-investment within a rental company's inventory is maximised by also deploying WPS arrays as front-fill, delay or side-hang support for larger WP systems.

WPS is a passive 3-way system which integrates a high density of drive units in a very compact enclosure. It features 2 x 8" (200mm) LF drivers, 4 x 4" (100mm) midrange drivers and 4 x 1" (25mm) exit HF compression drivers loaded by a moulded HF horn which occupies the full width of the enclosure — defining the 100° horizontal constant directivity coverage pattern of both the HF and midrange sections.

The 4" midrange drivers are compression-loaded to raise efficiency and enter the horn walls via annular slots close to the HF throat to sum effectively with the HF wavefront. In the HF section, four 1" exit compression drivers deliver pristine high frequency sound without the harshness and distortion associated with larger format devices.

The 8" LF drivers are set back behind the walls of the HF horn, with a small volume of air in front of each driver increasing the output at the upper end of its operating range. The LF exit apertures are spaced apart horizontally to provide useful LF horizontal pattern control.

For extended low frequency performance, WPS is designed to be partnered with the SXC118 cardioid subwoofer or its flyable variant, the SXCF118.





The scalable resolution of WPC offers greatly improved coverage consistency and control compared to a standard line array and provides a flexible pathway to advanced array optimisation.



WPC RESOLUTION MATRIX

	Benefits	Competitors	WPC
1-box Resolution Display Optimised	Hard Avoid® capability, improved audience consistency, electronically adjustable coverage		✓
2-box Resolution Display Optimised	Significantly improved audience coverage consistency over splay angles only, offering a compelling performance & price ratio		✓
3-box Resolution Display Optimised	Improved audience coverage consistency over mechanical optimisation		✓
Mechanical Optimisation via Display	Splay angles optimised using highly-accurate acoustic model; more consistent and faster than standard line array using basic geometric model		✓
Standard line array	Splay angles chosen by the user or calculated using basic geometric model	✓	✓

WPC is a new breed of medium-format optimised line array which brings innovative acoustic design, ultra-high performance and coverage consistency to a wider range of users, applications and budgets than previously possible. A three-way, bi-amp system, it features horn-loaded low frequency, mid and HF sections to raise efficiency and increase output. With a peak SPL of 135dB its high efficiency acoustic design can equal or outperform larger, direct radiator systems — a 12-box array will throw beyond 60 metres (200ft) and deliver impressive rock levels to a 5000-seat venue, saving on truck space and weight.

WPC's low frequency section consists of 2 x 10" (250mm) neodymium drivers in a Hybrid® configuration which marries the benefits of horn and reflex loading. Each driver is slot-loaded into a short horn to give a high sensitivity, while the rear of the driver is reflex-loaded to extend the LF output. The punch and low-frequency extension produced from such a small enclosure volume are remarkable.

Mid and HF horns are physically separate — a key factor in the WPC's exemplary 100° horizontal constant directivity dispersion pattern. The midrange horn design utilises 2 x 5" (125mm) neodymium drivers to produce a high output while the HF section employs 4 x 0.7" (19mm) exit neodymium compression drivers which feed 4 individual horns. Use of multiple small HF drivers instead of a more traditionally-used large format compression driver results in less distortion and a more extended HF response.



RECOMMENDED SUBWOOFERS

SXF115



The SXF115 is a passive subwoofer designed to extend the performance of WPM down to 42Hz. Featuring a powerful, long-excursion 15" (380mm)/4" (100mm) voice coil driver in a very compact bass reflex enclosure, it can be flown as part of a WPM array, or ground-stacked separately. Cardioid operation can be achieved by arranging the SXF115 in forward and rear-facing pairs.

The design of the 15" driver maximises output while minimising power compression and distortion, and four reflex ports reduce air noise at very high output levels. The SXF115 enclosure is constructed from multi-laminate birch ply, finished with a durable polyurethane coating and equipped with a perforated steel grille, skids and twin bar handles. An M20 threaded fitting in the top surface facilitates pole-mounting of up to 4 WPM enclosures.

SX118



The SX118 is a compact, high performance subwoofer that extends the low frequency operating range of the system to 47Hz and provides exceptional low frequency output for such a compact enclosure. An ideal partner for the WPM, it features a long-excursion 18" (460mm)/4" (100 mm) voice coil driver with a water-resistant cone and triple roll surround in a compact reflex enclosure.

The design of the 18" driver maximises output while minimising power compression and distortion, and the four reflex ports have a large frontal area to reduce turbulent air noise at very high levels. The enclosure is constructed from multi-laminate birch ply, finished with a durable polyurea coating and equipped with a Zintec grille, twin grab handles, skids, flying inserts for installation and a threaded pole socket for pole mounting up to 4 WPM enclosures as a simple plug-and-play system.

SXC118



Designed for touring sound and installations, the SXC118 is a compact, high performance cardioid subwoofer. It features an 18" (460mm) forward facing driver and a 14" (356mm) rear facing driver, each driven independently by separate amplifier channels and DSP.

Each driver has its own chamber with optimised bass reflex porting. This arrangement produces a cardioid dispersion pattern which maximises the front radiation and reduces unwanted radiation behind the subwoofer.

The SXC118 is an ideal partner for both WPM and WPS line arrays where low frequency pattern control is required.

SX218

The SX218 delivers very high output levels and superb transient performance with minimal distortion and it can partner both WPS and WPC, with one subwoofer to every 2 top boxes required. With an operating range of 35Hz-150Hz \pm 3dB, it houses dual 18" long excursion (460mm)/4" (100mm) voice coil drivers with water-resistant cones and triple roll surrounds. Each driver is rated to handle 1000 watts AES, and has a magnet structure and suspension engineered for maximum linear excursion.

The enclosure is constructed from multi-laminate birch ply and coated with hard-wearing polyurea coating. Eight reflex ports provide a large frontal area to reduce turbulent air noise, and a perforated steel grille protects the drivers from damage. SX218 features a M20 pole mount insert for added versatility in deployment.



SXH218

The SXH218 is the ultimate in subwoofer performance capable of producing 148dB peak output at 1m. It is the ideal partner for both WPS and WPC arrays where maximum low frequency output is required. Cardioid operation can be achieved by arranging the subwoofers in forward and rear-facing pairs.

Its Hybrid® horn/reflex loading combines the acoustic efficiency and impact of bass horn technology with the low frequency extension of a reflex design, enabling it to produce significantly higher output levels than a traditional reflex-loaded subwoofer.

With an operating range of 32-150Hz + 3dB, it features dual long-excursion 18" (460mm)/4.5" (115mm) voice coil neodymium drivers, with water resistant cones and triple roll surrounds.

The enclosure is constructed from multi-laminate plywood and coated with hard-wearing textured black polyurea. A rigid perforated steel grille protects the front of the enclosure, while interlocking skids protect the top and bottom surfaces and prevent movement when stacked.



TECHNICAL SPECIFICATIONS

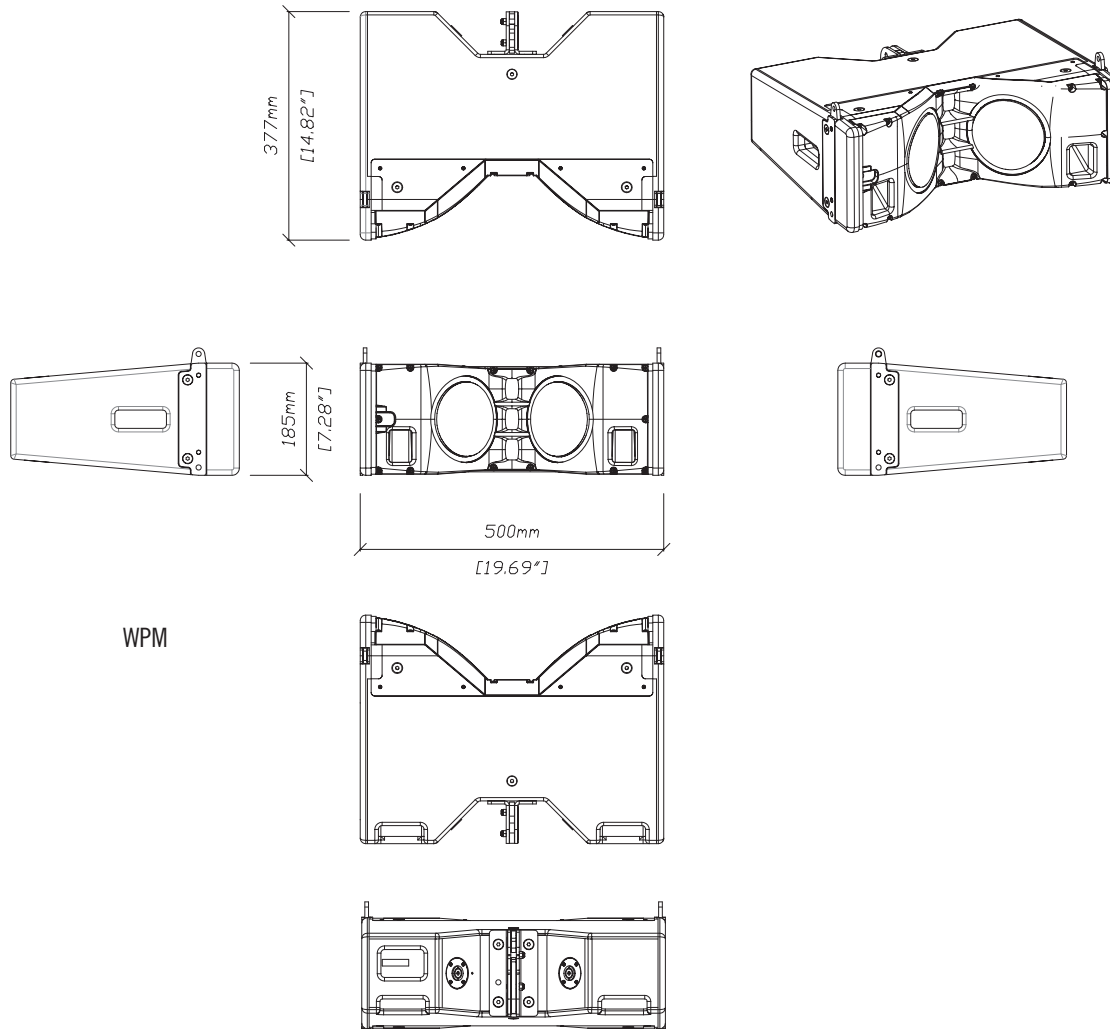

WPM

TYPE	Two-way, passive line array element
FREQUENCY RESPONSE (5)	76Hz-18kHz ± 3dB
DRIVERS	LF: 2 x 6.5" (165mm) contoured-diaphragm /2" (50mm) edge-wound CCAW voice coil, neodymium magnet drivers, reflex loaded HF: 3 x 1.4" (35mm) aluminium dome /1.4" (35mm) voice coil, neodymium magnet compression drivers on constant-directivity waveguide
SYSTEM AMPLIFIER	iKON iK42, iK81
SYSTEM RESOLUTION	1 to 4 enclosures per amplifier channel
MAXIMUM SPL (9)	130dB peak (1 cabinet)
NOMINAL IMPEDANCE	16 ohms
DISPERSION	100° horizontal (-6dB), 125° horizontal (-10dB) 10° vertical
CROSSOVER	1.2kHz passive
ENCLOSURE	Vertical trapezoid with 5° wall angle, Multi-laminate birch and poplar-ply construction
FINISH	Black textured paint
PROTECTIVE GRILLE	Black HEX perforated steel
CONNECTORS	2 x NL4 type
PIN CONNECTIONS (INPUT)	1+/1-
FITTINGS	Integral 3-point rigging system 2 x side pocket handles 2 x rear grip handles
FLOWN ARRAY MAXIMUM	16 enclosures in single array
DIMENSIONS	(W) 500mm x (H) 185mm x (D) 377mm (W) 19.7in x (H) 7.3in x (D) 14.8in
WEIGHT	14kg (30.9lbs)
ACCESSORIES	Install flying frame Touring flying frame Flying Pin

Notes

- (1) Measured on-axis in half (2pi) space at 2 metres, then referred to 1 metre.
- (2) AES Standard ANSI S4.26-1984.
- (3) Measured in half (2pi) space at 2 metres with 1 watt input, using band limited pink noise, then referred to 1 metre.
- (4) Measured in half (2pi) space at 2 metres using band limited pink noise, then referred to 1 metre.
- (5) Measured on-axis in open (4pi) space at 2 metres, then referred to 1 metre.
- (6) Measured in open (4pi) space at 2 metres with 1 watt input, using band limited pink noise, then referred to 1 metre.
- (7) Measured in open (4pi) space at 2 metres using band limited pink noise, then referred to 1 metre.
- (8) Measured in open (4pi) space at 2 metres with 2.83v input, using band limited pink noise, then referred to 1 metre.
- (9) Calculated at 1 metre.
- (10) Measured in half (2pi) space at 2 metres with 2.83V input, using band limited pink noise, then referred to 1 metre.

WPS

TYPE	Three-way, passive line array element
FREQUENCY RESPONSE (5)	70Hz-18000Hz ± 3dB
DRIVERS	LF: 2 x 8" (200mm)/2" (50mm) voice coil, long excursion, vented yoke, neodymium magnet drivers MF: 4 x 4" (100mm)/1" (25mm) coil, neodymium magnet drivers, compression loaded HF: 4 x 1" (25mm) exit/1.4" (35mm) HT Polymer diaphragm, neodymium magnet compression drivers
SYSTEM AMPLIFIER	iKON iK42
SYSTEM RESOLUTION	1 to 3 enclosures per amplifier channel (iK42)
MAXIMUM SPL (9)	133dB peak
NOMINAL IMPEDANCE	6 ohms
DISPERSION	100° horizontal (-6dB), 120° horizontal (-10dB), 10° vertical
CROSSOVER	520Hz, 1.6kHz internal passive
ENCLOSURE	Vertical trapezoid with 5° wall angle, multi-laminate birch and poplar-ply construction
FINISH	Black textured paint
PROTECTIVE GRILLE	Black HEX perforated steel
CONNECTORS	2 x NL4 type
PIN CONNECTIONS	1+/-
FITTINGS	3-point rigging system, 2 x side pocket handles 2 x rear grip handles
FLOWN ARRAY MAXIMUM DIMENSIONS	16 (installation) and 24 (touring) enclosures in a single array (W) 650mm x (H) 261mm x (D) 400mm (W) 25.6in x (H) 10.3in x (D) 15.8in
WEIGHT	27kg (60lbs)
ACCESSORIES	Install flying frame, Touring flying frame, Flying Pin

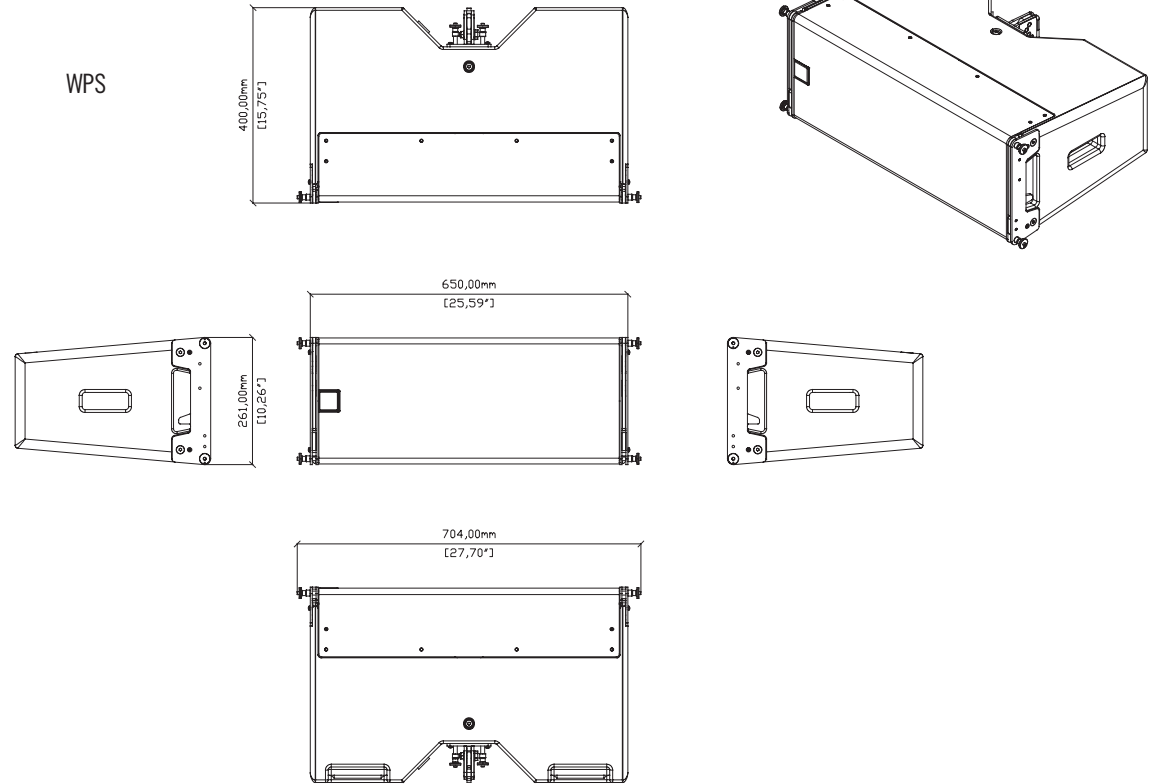

WPC

TYPE	Three-way, bi-amp line array element
FREQUENCY RESPONSE (5)	65Hz-18kHz ± 3dB
DRIVERS	LF: 2 x 10" (250mm)/2.5" (63mm) voice coil, long excursion, vented pole, neodymium magnet drivers, Hybrid® slot-horn loaded MF: 2 x 5" (125mm)/1.5" (38mm) coil, neodymium magnet drivers, horn loaded HF: 4 x 0.7" (19mm) exit neodymium magnet compression drivers, horn loaded
SYSTEM AMPLIFIER	iKON iK42
SYSTEM RESOLUTION	1 to 3 enclosures per pair of amplifier channels (Bi-amp)
MAXIMUM SPL (9)	135dB peak
NOMINAL IMPEDANCE	LF: 8 ohms, MF + HF: 8 ohms
DISPERSION	100° horizontal (-6dB), 130° horizontal (-10dB), 10° vertical
CROSSOVER	440Hz active, 4.4kHz internal passive
ENCLOSURE	Vertical trapezoid with 5° wall angle, multi-laminate birch and poplar-ply construction
FINISH	Black textured paint
PROTECTIVE GRILLE	Black HEX perforated steel
CONNECTORS	2 x NL4 type
PIN CONNECTIONS	LF: 1+/-, MF + HF: 2+/-
FITTINGS	3-point rigging system, 2 x side pocket handles 2 x rear grip handles
FLOWN ARRAY MAXIMUM DIMENSIONS	16 enclosures in single array (W) 772mm x (H) 319mm x (D) 421mm (W) 30.4in x (H) 12.6in x (D) 16.6in
WEIGHT	35kg (77.1lbs)
ACCESSORIES	Install flying frame, Touring flying frame, Flying Pin

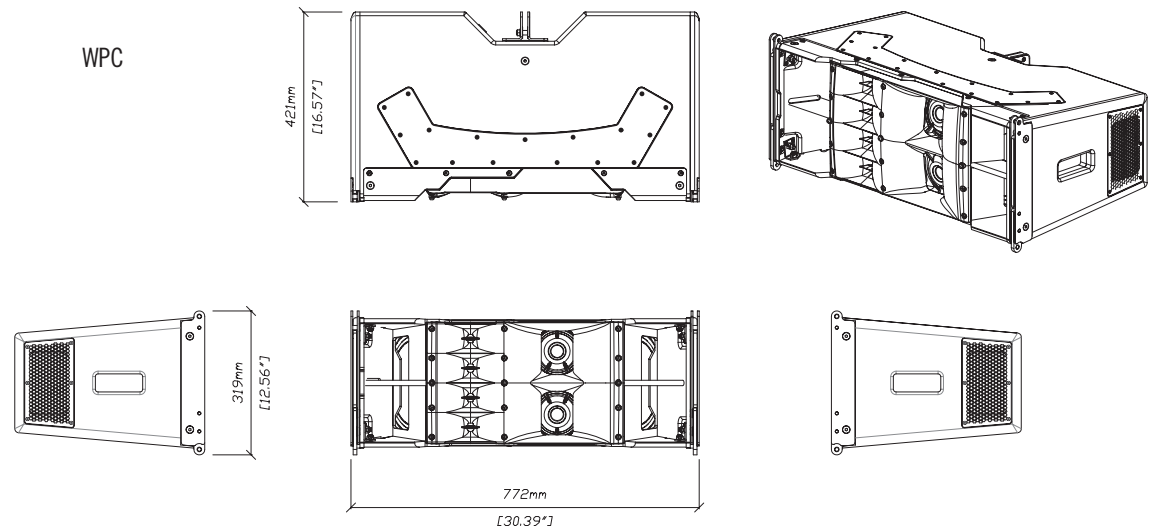

SXF115

TYPE	Compact, direct radiating subwoofer
FREQUENCY RESPONSE (1)	50Hz – 150Hz ±3dB, -10dB @ 42Hz
DRIVER	15" (380mm)/4" (100mm) voice coil, ultra-long excursion, ferrite magnet
RATED POWER (2)	800W AES, 3200W peak
SYSTEM AMPLIFIER	iKON iK42, iK81
SENSITIVITY (10)	103dB
MAXIMUM SPL(9)	136dB peak
NOMINAL IMPEDANCE	4 ohms
DISPERSION	Omnidirectional/or Cardioid (paired)
ENCLOSURE	Multi-laminate birch ply
FINISH	Textured black PU coating
PROTECTIVE GRILLE	Black HEX perforated steel
CONNECTOR	2 x NL4
PIN CONNECTIONS (INPUT)	LF: +1, -1 Link through: +2, -2
PIN CONNECTIONS (LINK)	LF: +1, -1 Link through: +2, -2
FITTINGS	Two skids on base, with mating channels on top M20 top-mounted thread plate for pole mounting Integral flyware for suspension of up to 4 SXF115 Large bar handle on each side Two front-mounted latch plates for wheelboard
DIMENSIONS (INCL SKIDS)	(W) 500mm x (H) 509mm x (D) 574mm (725mm incl wheelboard) (W) 19.7in x (H) 20in x (D) 22.6in (28.5in incl wheelboard)
WEIGHT	45kg (99lbs) 52kg (115lbs) incl wheelboard
ACCESSORIES	Wheelboard Transit cover

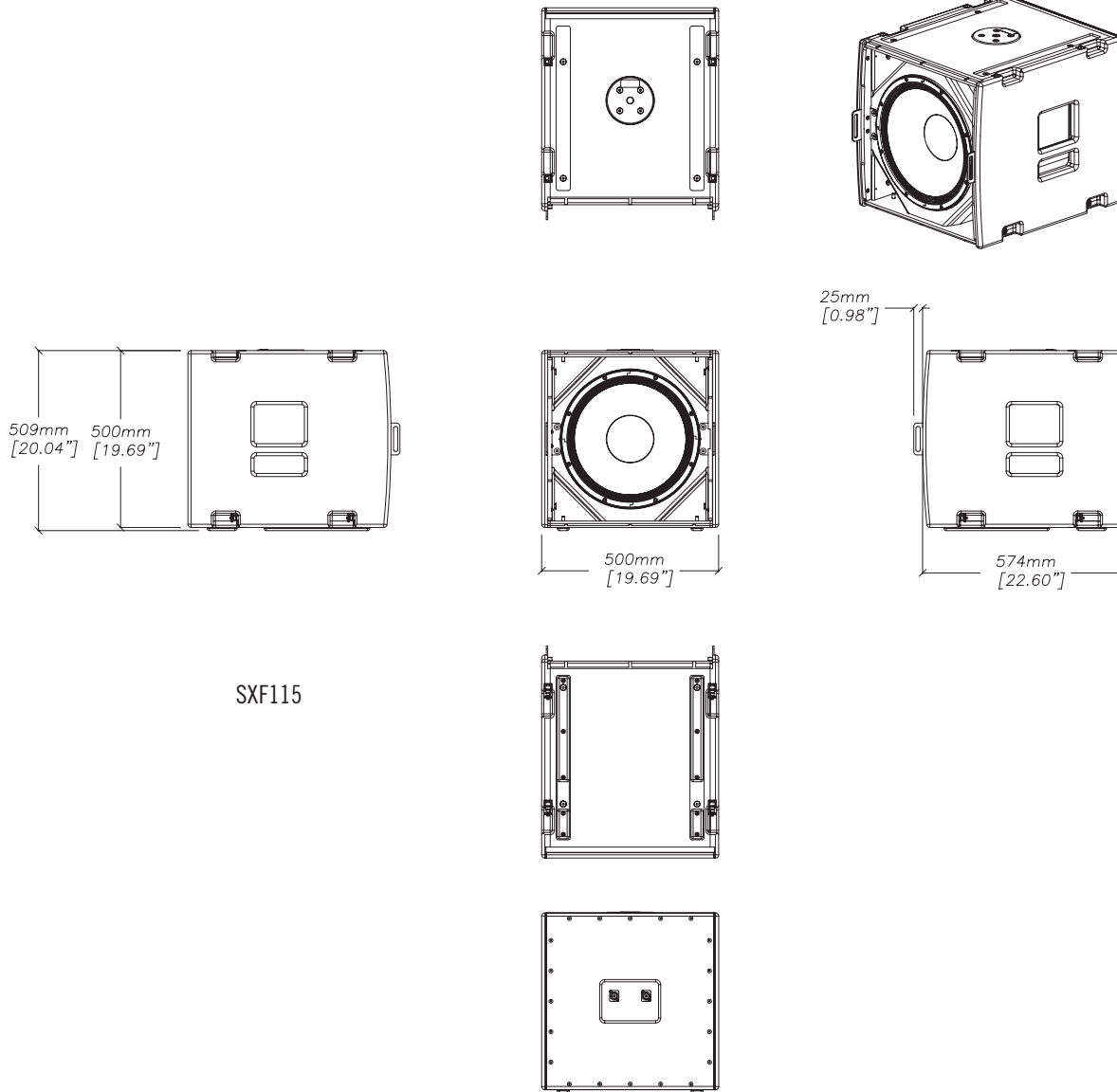

Notes

- (1) Measured on-axis in half (2pi) space at 2 metres, then referred to 1 metre.
- (2) AES Standard ANSI S4.26-1984.
- (3) Measured in half (2pi) space at 2 metres with 1 watt input, using band limited pink noise, then referred to 1 metre.
- (4) Measured in half (2pi) space at 2 metres using band limited pink noise, then referred to 1 metre.
- (5) Measured on-axis in open (4pi) space at 2 metres, then referred to 1 metre.
- (6) Measured in open (4pi) space at 2 metres with 1 watt input, using band limited pink noise, then referred to 1 metre.
- (7) Measured in open (4pi) space at 2 metres using band limited pink noise, then referred to 1 metre.
- (8) Measured in open (4pi) space at 2 metres with 2.83V input, using band limited pink noise, then referred to 1 metre.
- (9) Calculated at 1 metre.
- (10) Measured in half (2pi) space at 2 metres with 2.83V input, using band limited pink noise, then referred to 1 metre.

SX118

TYPE	Compact, direct radiating subwoofer
FREQUENCY RESPONSE (1)	47Hz – 150Hz ±3dB, -10dB @ 41Hz
DRIVER	18" (460mm)/4" (100mm) voice coil, long excursion, ferrite magnet, waterproof cone
RATED POWER (2)	1000W AES, 4000W peak
SYSTEM AMPLIFIER	iKON iK42, iK81
SENSITIVITY (10)	102dB
MAXIMUM SPL(9)	138dB peak
NOMINAL IMPEDANCE	8 ohms
DISPERSION (-6dB)	Omnidirectional/or Cardioid (paired)
ENCLOSURE	Multi-laminate birch/poplar ply
FINISH	Durable polyurea coating
PROTECTIVE GRILLE	Black perforated Zintec
CONNECTORS	2 x NL4
PIN CONNECTIONS (INPUT)	LF: +1, -1 Link through: +2, -2
PINS CONNECTIONS (LINK)	LF: +1, -1 Link through: +2, -2
FITTINGS	Two skids on base, with mating channels on top Four rear-mounted 100mm (4in) castors M20 top-mounted thread plate for pole mounting 16 x M10 mounting points, 2 x bar handles, 1 on each side
DIMENSIONS (INCL SKIDS)	(W) 600mm x (H) 509mm x (D) 632mm (760mm including castors) (W) 24in x (H) 20.36in x (D) 25.26in (30.38in including castors)
WEIGHT	43.5kg(96lbs) w/o castors, 47kg(104lbs) with castors
ACCESSORIES	Wheel Kit (Four 100mm (4in) castors), Input Board Cover, Transit Cover

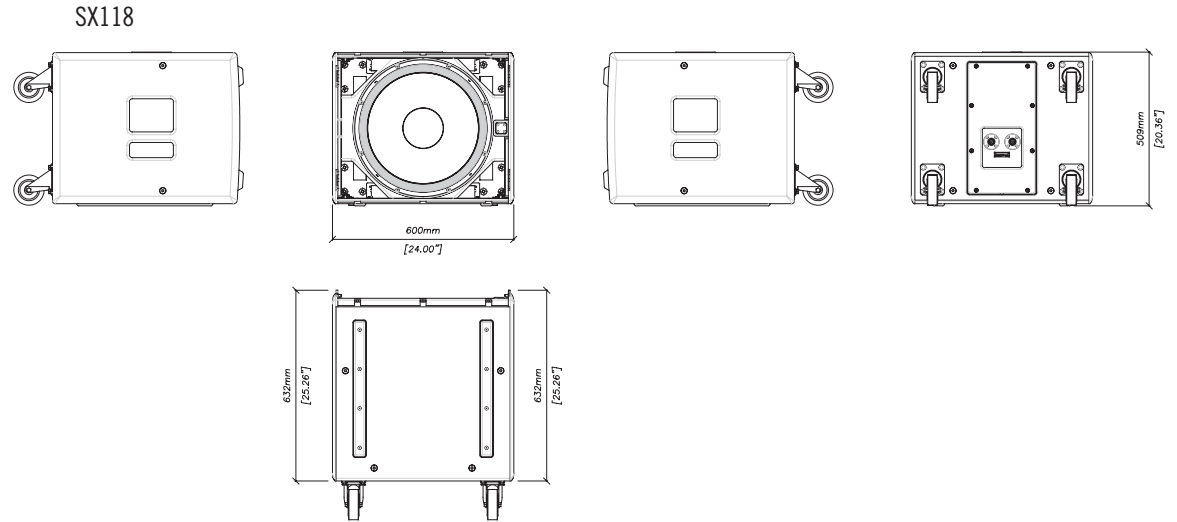

SXC118

TYPE	Compact, cardioid subwoofer
FREQUENCY RESPONSE (1)	43Hz – 150Hz ±3dB, -10dB @ 34Hz
DRIVERS	18" (460mm)/4" (100mm) voice coil, long excursion, ferrite magnet, waterproof cone 14" (356mm)/3.5" (88mm) voice coil, long excursion, neodymium magnet, waterproof cone
RATED POWER (2)	18": 1000W AES, 4000W peak 14": 800W AES, 3200W peak
SYSTEM AMPLIFIER	iKON iK42
SENSITIVITY (10)	104dB
MAXIMUM SPL(9)	140dB peak
NOMINAL IMPEDANCE	18": 8 ohms, 14": 8 ohms
DISPERSION	Cardioid
ENCLOSURE	Multi-laminate birch and poplar ply
FINISH	Textured black paint
PROTECTIVE GRILLE	Black HEX perforated steel
CONNECTOR	2 x NL4
PIN CONNECTIONS (INPUT)	18": +1, -1; 14": +2, -2
PIN CONNECTIONS (LINK)	18": +1, -1; 14": +2, -2
FITTINGS	Two skids on base, with mating channels on top M20 top-mounted thread plate for pole mounting Two bar handles on each side Four fittings for optional transit cover 16 x M8 inserts for optional castors
DIMENSIONS (INCL SKIDS)	(W) 650mm x (H) 603mm x (D) 812mm (940mm incl castors) (W) 25.6in x (H) 23.7in x (D) 32in (37in incl castors)
WEIGHT	69kg (152lbs), 73kg (161lbs) incl castors
ACCESSORIES	Transit cover, 16 x M8 inserts for optional castors

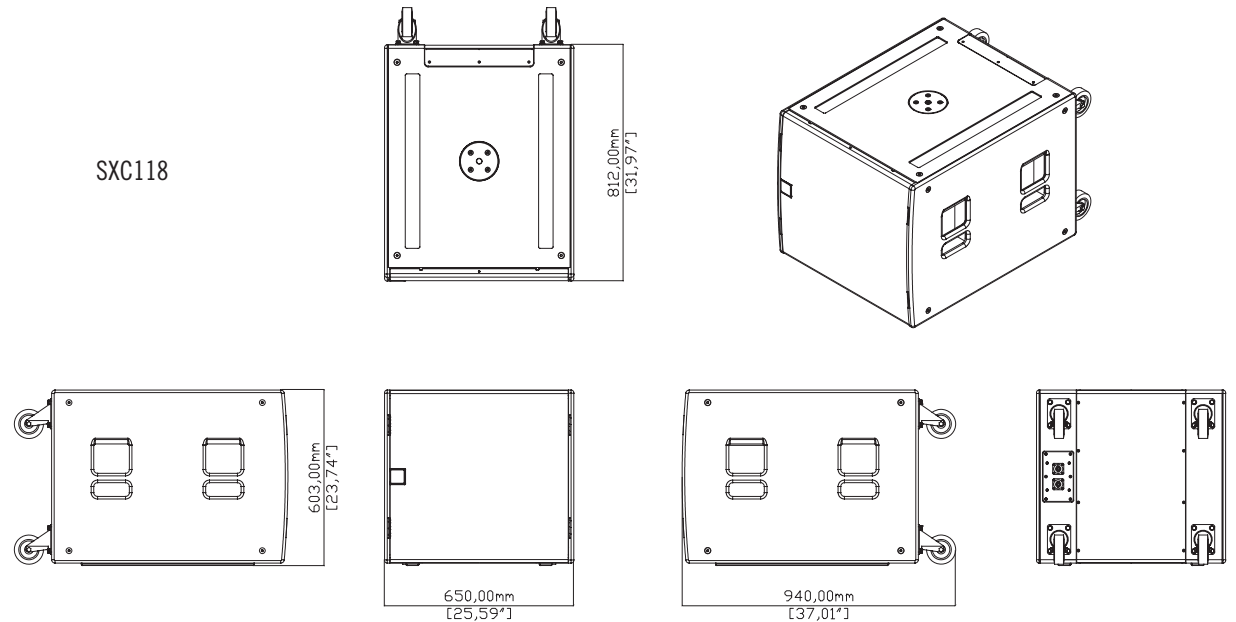

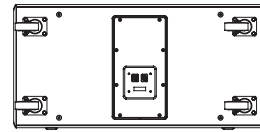
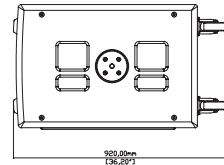
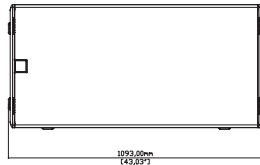
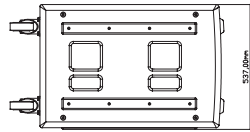
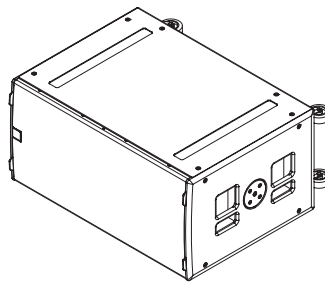
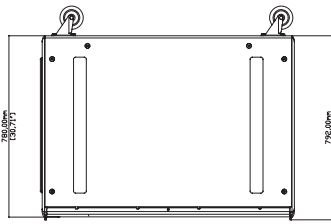

SX218

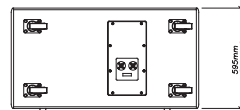
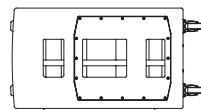
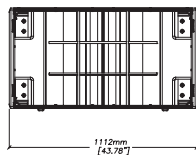
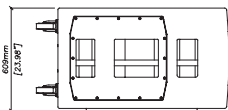
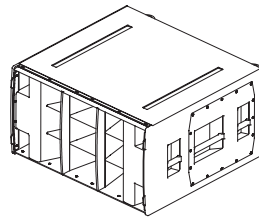
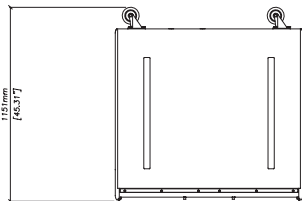
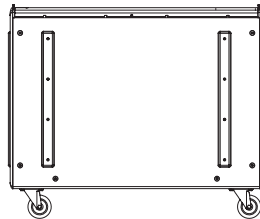

SXH218

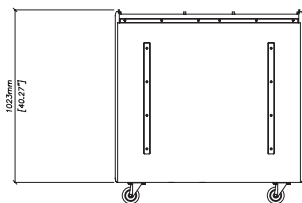

SX218

TYPE	Dual-driver, direct radiating subwoofer
FREQUENCY RESPONSE (1)	35Hz – 150Hz ±3dB, -10dB @ 30Hz
DRIVER	2 x 18" (460mm)/4" (100mm) voice coil, long excursion, ferrite magnet, waterproof cone
RATED POWER (2)	2000W AES, 8000W peak
SYSTEM AMPLIFIER	iKON iK42
SENSITIVITY (10)	105dB
MAXIMUM SPL(9)	144dB peak
NOMINAL IMPEDANCE	2 x 8 Ohms
DISPERSION (-6dB)	Omnidirectional/or Cardioid (paired)
ENCLOSURE	Multi-laminate birch/poplar ply
FINISH	Durable polyurea coating
PROTECTIVE GRILLE	Black perforated Zintec
CONNECTORS	2 x NL4
PIN CONNECTIONS (INPUT)	LF1: 1+, 1- LF2: 2+, 2-
PINS CONNECTIONS (LINK)	LF1: 1+, 1- LF2: 2+, 2-
FITTINGS	Two skids on base, with mating channels on top Four rear-mounted 100mm (4in) castors 24 x M10 mounting points 4 x bar handles, 2 on each side M20 Pole mount insert
DIMENSIONS (INCL SKIDS)	(W) 1093mm x (H) 537mm x (D) 792mm (920mm including castors) (W) 43in x (H) 21.1in x (D) 31.2in (36.2in including castors)
WEIGHT	98.5kg (217lbs) w/o castors 102kg (225lbs) with castors
ACCESSORIES	Wheel Kit (Four 100mm (4in) castors), Input Board Cover, Transit Cover

SXH218

TYPE	Hybrid® horn/reflex subwoofer
FREQUENCY RESPONSE (1)	32Hz – 150Hz ±3dB, -10dB @ 27Hz
DRIVERS	2 x 18" (460mm)/4.5" (115mm) voice coil, long excursion, neodymium magnet, waterproof cone
RATED POWER (2)	3000W AES, 12000W peak
RECOMMENDED AMPLIFIER	iKON iK42
SENSITIVITY (10)	107dB
MAXIMUM SPL(9)	148dB peak (at 1m half space)
NOMINAL IMPEDANCE	4 Ohms
DISPERSION (-6dB)	Omnidirectional/or Cardioid (paired)
ENCLOSURE	Multi-laminate birch/poplar ply
FINISH	Textured Black Polyurea
PROTECTIVE GRILLE	Black perforated steel
CONNECTORS	2 x NL4
PIN CONNECTIONS	Input: +1/-1, refer to input panel for four-core cable link diagram
FITTINGS	Two skids on base, with mating channels on top Four rear-mounted 100mm (4in) castors 6 x bar handles, 3 on each side 4 x fittings for optional transit cover
DIMENSIONS (INCL SKIDS)	(W) 1112mm x (H) 609mm x (D) 1023mm (1151mm incl. castors) (W) 43.8in x (H) 23.9in x (D) 40.27in (45.31in incl. castors)
WEIGHT	116kg (256lbs), with castors 120kg (265lbs)
ACCESSORIES	Transit cover

iK42

General

TYPE	Four-channel Class D amplifier
TOTAL OUTPUT POWER	20,000 Watts RMS, all channels driven
DIGITAL SIGNAL PROCESSING	96kHz DSP on all inputs and outputs
COOLING	Dual vari-speed fans, front-to-back airflow
MAXIMUM AMBIENT TEMPERATURE	40°C (104°F)

Audio Inputs/Outputs

ANALOGUE IN/LINK (4 CHANNELS)	4 x female, 4 x male Neutrik™ XLR
ANALOGUE INPUT IMPEDANCE	20kΩ balanced to ground
MAXIMUM ANALOGUE INPUT LEVEL	+20dBu
NOMINAL SYSTEM GAIN	32dB
AES3 IN/LINK (2 CHANNELS)	1 x female, 1 x male Neutrik™ XLR, balanced
DANTE™ (4 CHANNELS)	2 x shielded RJ45, primary and secondary
AMPLIFIER OUTPUTS	4 x Neutrik Speakon™ NL4

Control and Monitoring Network

TOPOLOGY	Ethernet
CONTROL APPLICATION	Martin Audio VU-NET™

Power Supply

TYPE	High performance Series Resonant
AC INPUT OPERATING RANGE	85 – 240V ~ AC, 47 - 63Hz
MAINS INRUSH CURRENT	6A at 115V, 12A at 230V (max for <10ms)
MAINS CONNECTOR	Neutrik 32A Powercon™

Physical

DIMENSIONS	(W) 482mm x (H) 2U/88mm x (D) 441mm (W) 18.98in x (H) 2U/3.46in x (D) 17.35in incl handles and optional rear support
WEIGHT	12.5kg (27.5lbs)

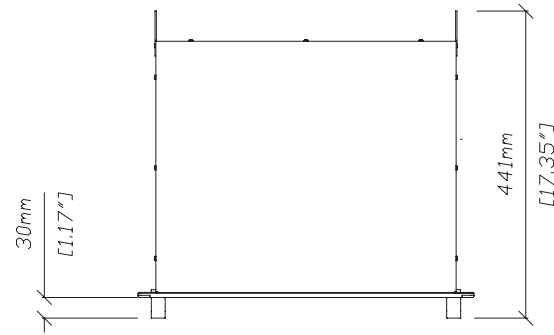

iK42

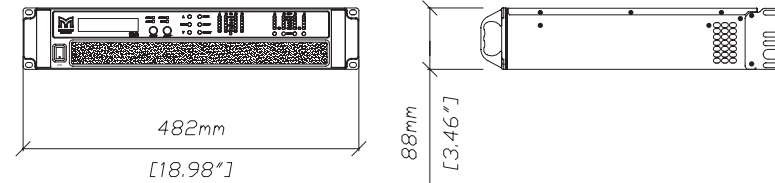

iK81

General

TYPE	Eight-channel Class D amplifier
TOTAL OUTPUT POWER	10,000 Watts RMS, all channels driven
DIGITAL SIGNAL PROCESSING	96kHz DSP on all inputs and outputs
COOLING	Dual vari-speed fans, front-to-back airflow
MAXIMUM AMBIENT TEMPERATURE	40°C (104°F)

Audio Inputs/Outputs

ANALOGUE IN/LINK (4 CHANNELS)	4 x female, 4 x male Neutrik™ XLR
ANALOGUE INPUT IMPEDANCE	20kΩ balanced to ground
MAXIMUM ANALOGUE INPUT LEVEL	+20dBu
NOMINAL SYSTEM GAIN	32dB
AES3 IN/LINK (2 CHANNELS)	1 x female, 1 x male Neutrik™ XLR, balanced
DANTE™ (4 CHANNELS)	2 x shielded RJ45, primary and secondary
AMPLIFIER OUTPUTS	4 x Neutrik Speakon™ NL4

Control and Monitoring Network

TOPOLOGY	Ethernet
CONTROL APPLICATION	Martin Audio VU-NET™

Power Supply

TYPE	High performance Series Resonant
AC INPUT OPERATING RANGE	85 – 240V ~ AC, 47 - 63Hz
MAINS INRUSH CURRENT	6A at 115V, 12A at 230V (max for <10ms)
MAINS CONNECTOR	Neutrik 32A Powercon™

Physical

DIMENSIONS	(W) 482mm x (H) 2U/88mm x (D) 441mm (W) 18.98in x (H) 2U/3.46in x (D) 17.35in incl handles and optional rear support
WEIGHT	12.5kg (27.5lbs)

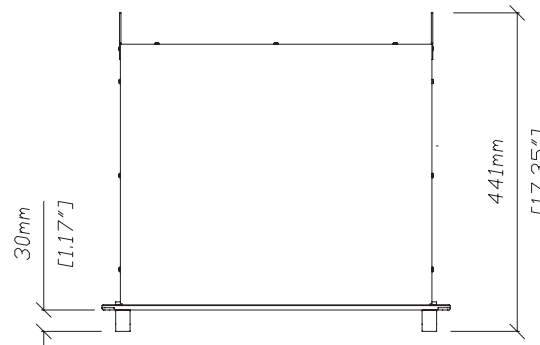

iK81

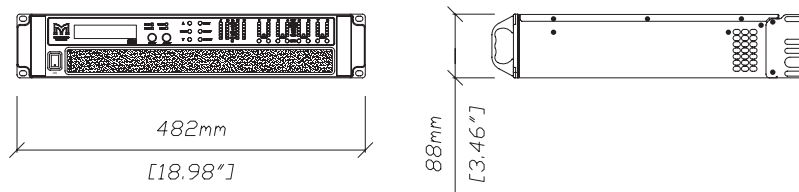



WAVEFRONT
PRECISION

WPM WPS WPC

Martin Audio Limited

Century Point

Halifax Road

Cressex Business Park

High Wycombe

Buckinghamshire

HP12 3SL

England

FOR SALES ENQUIRIES:

UK

Telephone: +44 (0)1494 535312

E-mail: info@martin-audio.com

NORTH AMERICA

Telephone: 323 381 5310

www.martin-audio.com

All information is Copyright © 2021 Martin Audio Ltd.

Martin Audio, the Martin Audio logo and Hybrid are registered trademarks of Martin Audio Ltd. in the United Kingdom, United States and other countries; all other Martin Audio trademarks are the property of Martin Audio Ltd.



Unite Your Audience
The Martin Audio Experience



2021



Version 4.5