

Optimal Audio



USER GUIDE

Zone 8 & 8P

8 zone audio controller with DSP and WebApp

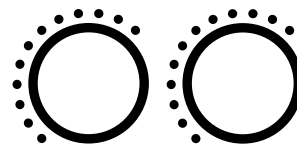

Controllers

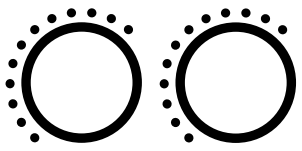

Controllers

Zone 8 & 8P

8 zone audio controller with DSP and WebApp

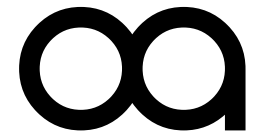

Optimal Audio

Contents

USER GUIDE

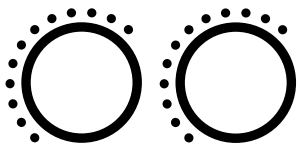

Controllers

Zone 8 & 8P

8 zone audio controller with DSP and WebApp

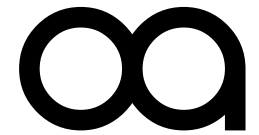

Optimal Audio



Congratulations on your choice of Optimal Audio for your latest sound system installation.

The Optimal Audio range of compatible audio zoners, amplifiers and loudspeakers are designed to work together simply and effectively. Our quick start guides will take you through the simple connection and set up procedure.

Zone 8 and 8P are powerful and flexible audio signal routers and processors that are the heart of your system. They have been designed to be easy to set up and operate, even if you have very little previous experience of similar equipment.

With Zone 8 and 8P it is possible to combine audio sources such as streaming services, radio, computer audio or anything with an audio output and create separate mixes in up to eight separate zones. Zones can be thought of as different rooms or areas where you would want to establish a different musical ambience. For ideas on how this might work for you, be sure to check out our Optimal Audio Application examples on optimal-audio.co.uk

This quick start guide will help you get up and running as quickly as possible, with minimum fuss, and ensure you get the best results from your system.

Helpful Tip

Prior to installation of Zone, please check for latest **firmware update**.

<https://optimal-audio.co.uk/support/software>

USER GUIDE

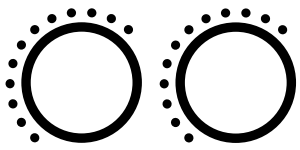

Controllers

Zone 8 & 8P

8 zone audio controller with DSP and WebApp

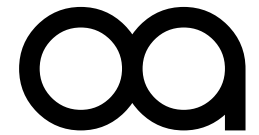

Optimal Audio

Updating firmware

BEFORE POWERING ON THE UNIT

Before setting up Zone via WebApp for the first time it is important to ensure that the unit is running the latest firmware.

The instructions below apply to any computer operating system.

- Extract the SD Card from the rear of the Zone unit by gently pushing it in. If your laptop or desktop has a slot for an SD Card, insert the Optimal Audio branded SD Card until it latches. If you do not have a suitable SD Card slot, you will need to use a USB SD Card adapter. These are readily available.
- Go to the software download page <https://optimal-audio.co.uk/support/software/> and download the Zone Bundle containing the latest firmware.
- Copy this file, *system.bundle* to the SD Card – place it in the root directory of the SD Card. Do not place it in a folder.
- Once copied, safely remove the SD Card from the reader and place it back in the slot on the rear of your Zone.
- Connect to your network (see page 5).
- Connect Zone to power – and the update process will start automatically.
- On the front panel, the power light will show blue – the unit is checking the SD Card and it will flicker as the bundle is unpacked.
- If the firmware on the card is new, the unit will update – the light will flash orange.
- Once the firmware is up to date, the light will turn green, indicating that Zone is booting up. This takes between 20 – 30 seconds.
- Flashing green indicates searching for an IP address.
- If the network connection is good and the unit has a suitable IP address, the indicator will turn white and the remaining front panel lights will illuminate.
- Your firmware is now updated and you are ready to launch WebApp.

Light	Colour	Mode	Zone Status	User Action
Power	Blue	Solid	Unit startup	Wait. If no SD card is present, the unit will not boot and will show a continuous blue light.
	Blue	Flashing	The unit is unpacking a system bundle file onto the SD card	Wait
	Orange	Flashing	Updating firmware	Wait
	Green	Solid	Booting up	Wait. Once booted and the front panel controls are showing, if the unit is being used without a network a solid green light will show.
	Green / White	Flashing	The FUNC button was held at startup - a network change is taking place	See page 5
	Green	Flashing	Searching for IP address	Wait
	White	Solid	Unit on, network connection good, IP address assigned	Ready to use
	Red	Solid	Software fault	The unit has encountered an unrecoverable error. Please contact support.
Protect	Red	Solid	System fault – audio will not pass on affected channel	Power down, investigate fault
Temp	Red	Solid	Unit is overheating	Power down, clean fan filters
Clip	Red	Solid or Flashing	Audio signal overload	In WebApp, check sources and outputs for excessive volume and turn down as appropriate

USER GUIDE

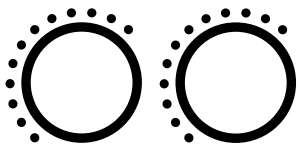

Controllers

Zone 8 & 8P

8 zone audio controller with DSP and WebApp

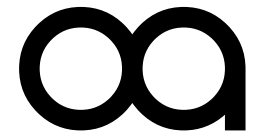

Optimal Audio



Helpful Tip

Network connectivity
For more information about WebApp and network connectivity refer to the WebApp user guide.

<https://optimal-audio.co.uk/support/downloads/>

Introducing Zone 8 & 8P

All Zone products have the same input capacity across the range:
Four stereo line inputs allow the connection of sound sources such as streamers, CD players, laptops or anything that has a stereo analogue audio output.

Two standard HDMI connectors provide simple stereo audio input connectivity with audio-visual equipment such as DVD players, laptops and off-air TV receivers.

Two microphone inputs with 48V phantom power.

Two inputs for future Optimal Audio paging stations, or to connect additional ZonePad 4 wall controllers.

Zone 8 has eight balanced line outputs that can be configured as mono or stereo zone outputs in WebApp. The Zone 8P also has eight integral channels of amplification.

Both models have the ability to accept connections with up to eight ZonePad 1 or ZonePad 4 wall-mounted controllers.

USER GUIDE

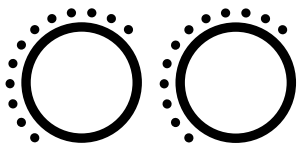

Controllers

Zone 8 & 8P

8 zone audio controller with DSP and WebApp

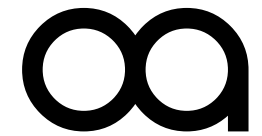

Optimal Audio

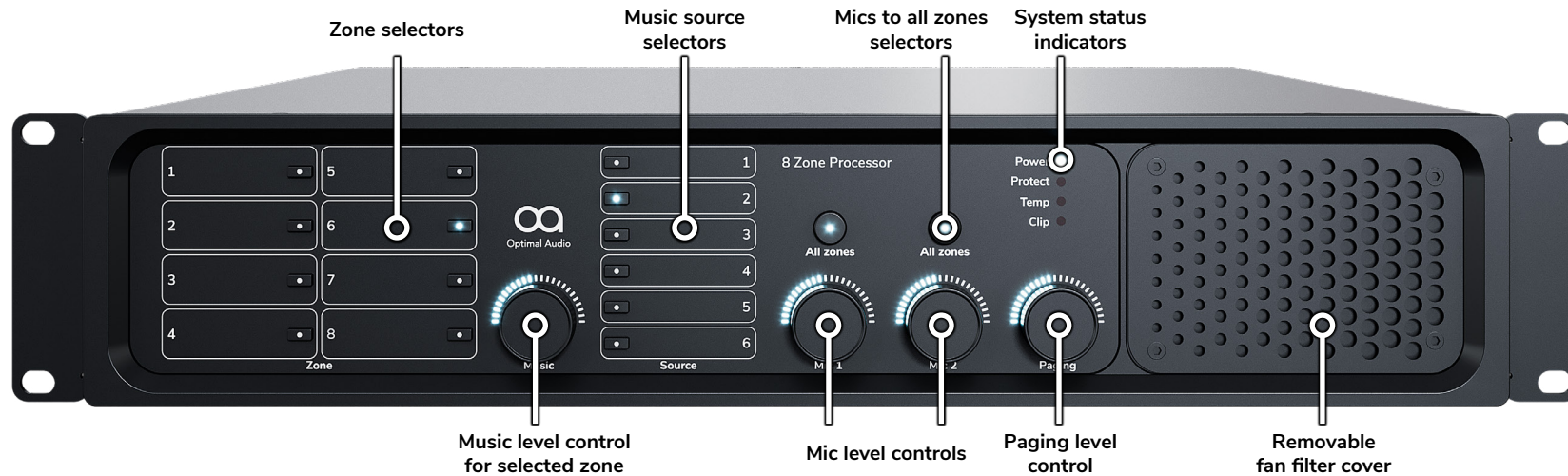

Front panel

The zone selector buttons allow you to choose which zone of your system you wish to adjust. There's plenty of space for a label to make sure you know exactly which part of the system you are controlling.

Once you have selected your zone, you can then choose a music source to be routed to that zone.

The music level control will then allow you to adjust the level of your chosen source, in your chosen zone.

In addition, the two microphone inputs have individual level controls to enable your message to be heard at just the right volume in each zone. Select the zone and adjust the relevant mic level control.

Should you wish to control the microphone levels in all zones at once, hit the button above the knob for either Mic 1 or 2.

And finally, there is a volume control for the paging stations.

USER GUIDE

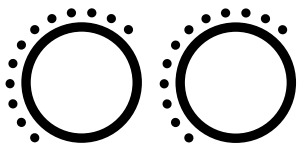

Controllers

Zone 8 & 8P

8 zone audio controller with DSP and WebApp

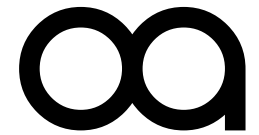

Optimal Audio

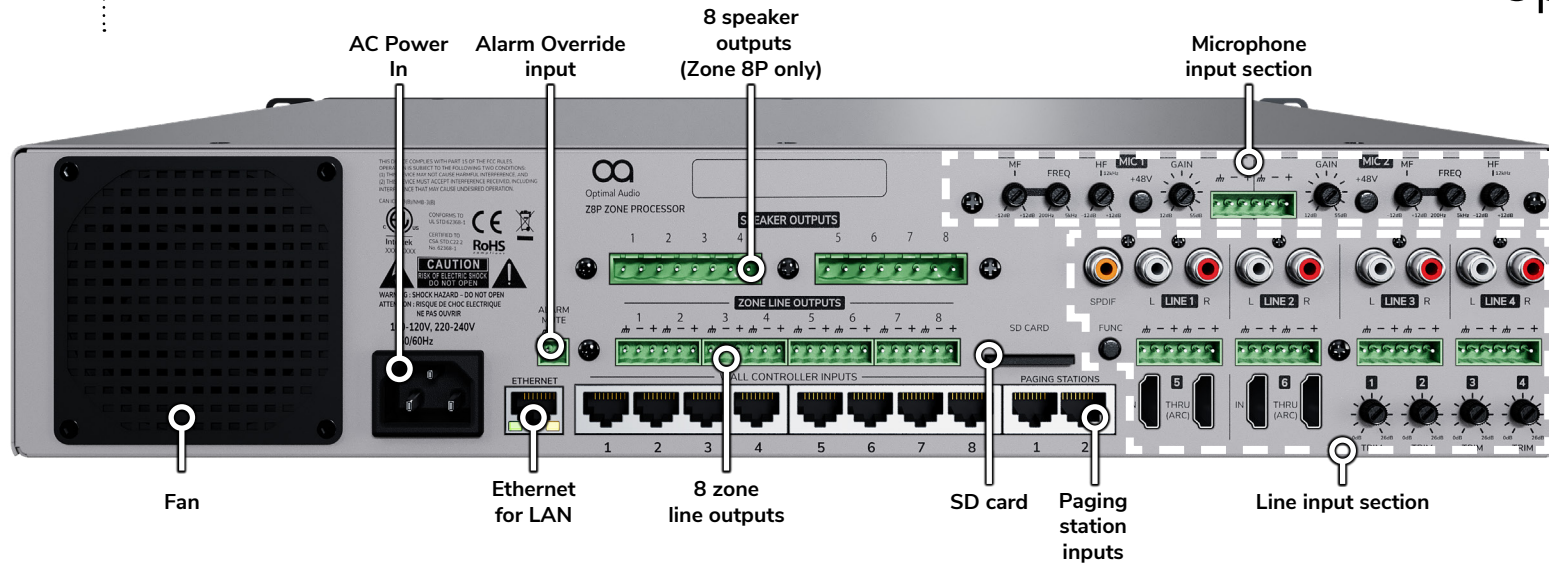

Rear panel

A standard IEC mains connector supplies the unit with AC power between 100 and 240 volts.

The ethernet socket allows you to connect Zone 8 and 8P to a router to give you wired or wireless control via the Optimal Audio WebApp.

An alarm override ensures that any alarm system will mute all outputs via contact closure.

Up to eight Optimal Audio ZonePad wall controllers are connected via standard RJ45 connectors, using a proprietary Optimal Audio protocol to provide power, data and audio over CAT 5 cable.

Zone 8 delivers audio to eight separate outputs. These audio outputs can be routed to any zone via WebApp. For example, channel one, two and three could be routed to left, right and mono sum for one zone. It supports up to 8 zones allowing many combinations of zones and speakers as your installation requires.

Zone 8P differs from Zone 8 with the addition of eight loudspeaker outputs with the ability to bridge channels via WebApp. For more information about the outputs on Zone8P go to page 16.

The SD card provided with the unit stores all settings and system files. It must always be present in the unit for correct operation. It can also be used to copy system setup to another unit if you require a number of devices to perform very similar functions or repeat system configurations across several venues.

Zone 8 and 8P have two inputs for future paging stations, again using Optimal Audio proprietary protocol over standard CAT5 cable. These inputs can also be used for additional ZonePad 4 units.

Two microphone inputs are provided, four stereo line inputs and two stereo HDMI inputs and HDMI thru for video only output.

USER GUIDE

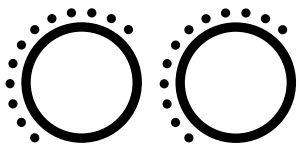

Controllers

Zone 8 & 8P

8 zone audio controller with DSP and WebApp

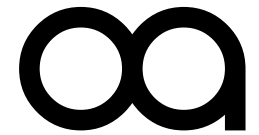

Optimal Audio

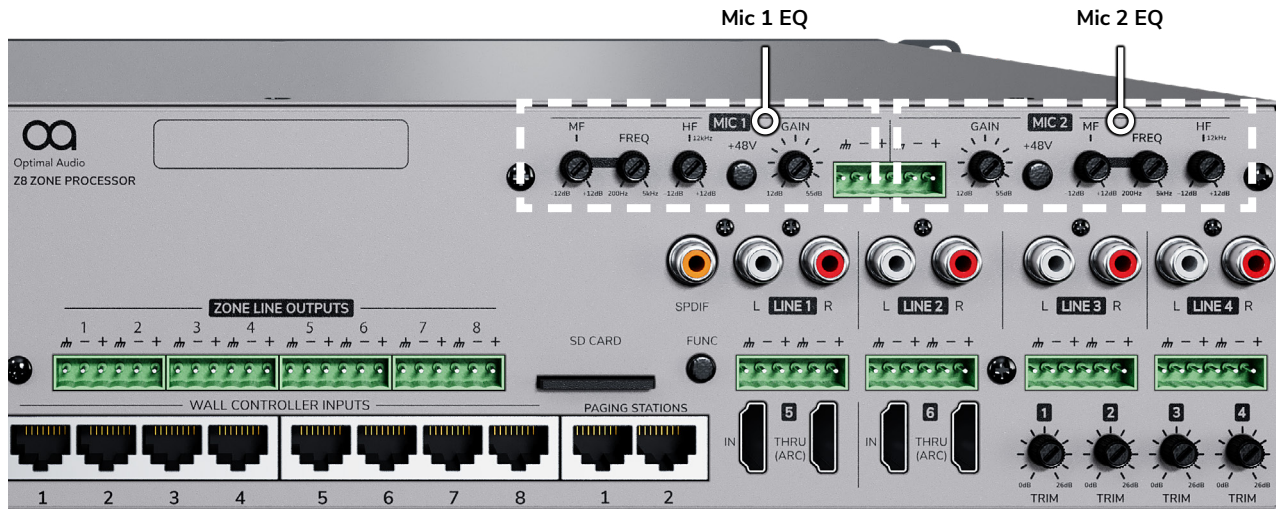

Input section detail – mic inputs –
Input 1 only shown for clarity
(controls are repeated for mic input 2)

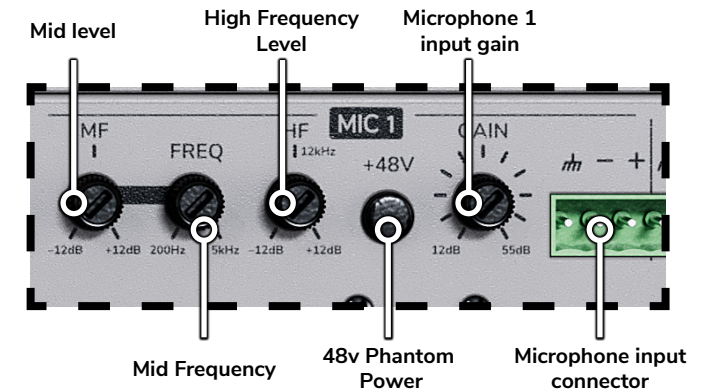

Microphone inputs

The two inputs are identical apart from the fact that the controls are laid out as a mirror of each other.

Immediately adjacent to the input connectors are the mic input gain controls. Correct gain adjustment for your microphone is essential to ensure good signal control throughout your system. Generally speaking, dynamic microphones will require more gain than condenser microphones.

The 48V Phantom Power button will allow you to use high-quality condenser mics with Zone 8 and 8P. If you are using a condenser mic, engage Phantom Power for your mic to function.

The next three controls are for setting a basic equalization for your mic input. They are independent of any equalization in WebApp. These are useful for tailoring your sound to a particular voice/microphone combination.

Use the High frequency control for increasing or decreasing sibilance, which can help with intelligibility. The mid-range controls allow you to choose the frequency around which you can boost or cut, between 200Hz and 5kHz. The lower mid frequencies will affect warmth and muddy sounding voices, the middle range will help to stop 'boxiness', and the higher frequencies will assist with intelligibility or harshness.

USER GUIDE

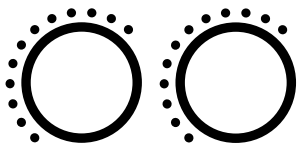

Controllers

Zone 8 & 8P

8 zone audio controller with DSP and WebApp

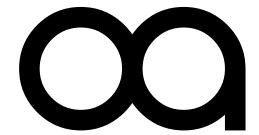

Optimal Audio

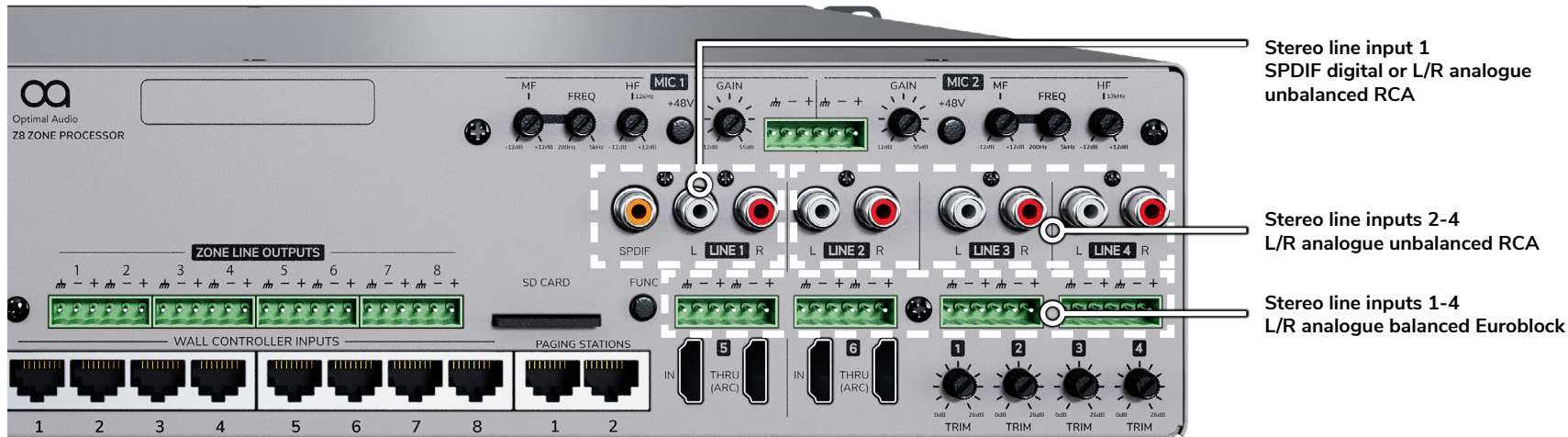

Line inputs

Below the mic inputs are the connections for line inputs 1 – 4

These are where the outputs of your music sources will be plugged in to Zone 8.

They are all identical except for Line Input 1. All are stereo analogue inputs, however Input 1 also has the option to use a standard SPDIF digital audio connection, which will give you full stereo reproduction on a single cable when connected with compatible equipment. This is clearly labelled and features an orange phono socket. SPDIF signals are not suitable for cable lengths greater than 10 metres.

Each input has a standard red and white coloured pair of RCA sockets for connecting units which are placed locally to the Zone 8, such as a streamer in the same equipment rack. These inputs are not suitable for connection of equipment located remotely from the Zone 8 and 8P.

For the connection of more remote sound sources there are four stereo balanced line inputs on Euroblock connectors. In all cases you should decide which you are going to use before hooking up, and never use two different types of connection at the same time on the same input.

To the right of the HDMI inputs are four gain trim controls for inputs 1 – 4. These give you the ability to adjust the inputs to accept a signal from consumer level at -10dBV to pro level +20dBu maximum.

USER GUIDE

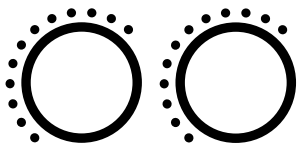

Controllers

Zone 8 & 8P

8 zone audio controller with DSP and WebApp

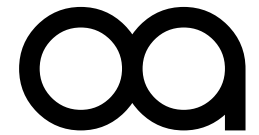

Optimal Audio

Input Cables and Wiring

It is important to decide whether you are going to use the balanced or unbalanced inputs. As a rule of thumb, unbalanced inputs should be used to connect sources that are located close to your Zone unit – in the same equipment rack for example.

Longer cable runs are more susceptible to noise - using balanced inputs will minimise unwanted noise.

Unbalanced Circuits

In an unbalanced circuit, the signal is carried on a single conductor and the shield, or ground. The shield is designed to help reduce interference, but if unwanted noise is introduced on the single conductor, it is added to the signal and arrives at the input, where it is seen as one and the same thing as the audio and will be heard as hum, buzz or other noise.

Unbalanced circuits are generally fine for short cable runs, and are found on most domestic and commercial AV equipment.

Balanced Circuits

In a balanced circuit, the signal is sent on two conductors. The source sends the signal and an inverted signal. Any noise is induced equally on each conductor, with the same polarity. On arrival at the input the two signals are summed and the inverted signal has its polarity reversed – this cancels noise. The shield acts as just that, to help minimise any induced noise.

UNBALANCED CIRCUIT

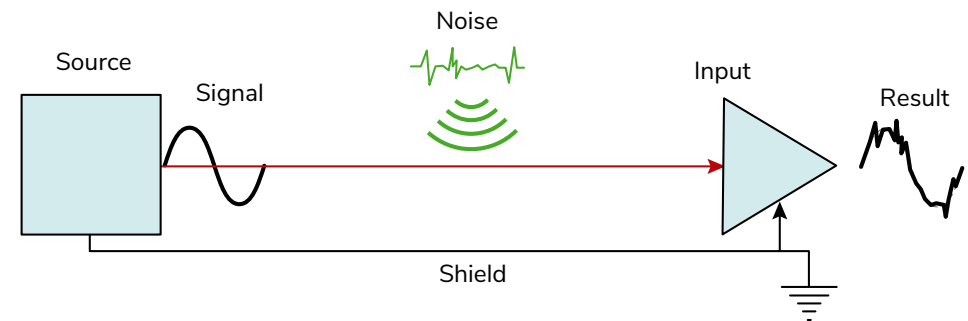

BALANCED CIRCUIT

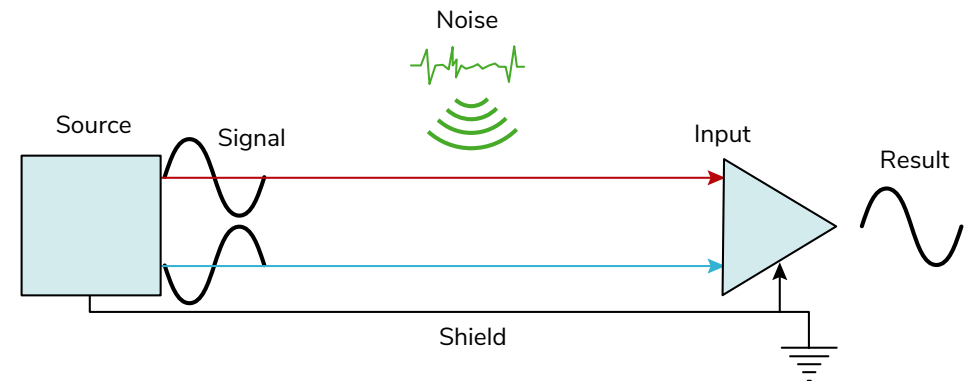

USER GUIDE

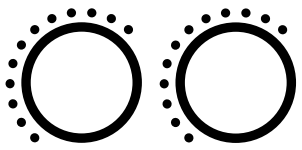

Controllers

Zone 8 & 8P

8 zone audio controller with DSP and WebApp

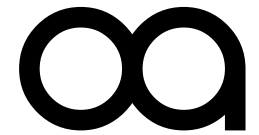

Optimal Audio

Connecting Balanced Audio Equipment

If you are connecting a piece of audio equipment that has balanced line outputs on a 3 pin XLR, a mixer or a DJ console for example, you will need a female XLR for the equipment end wired to the appropriate Euroblock connector for the input on Zone.

The little green Euroblock connectors are supplied with your Optimal Audio Zone and SmartAmp products. It's really important to follow the pin connections correctly. The cable you use will have clearly defined cores, and they must connect the three pins on each connector together as shown in the table.

When you solder up the XLR look very carefully at the numbers on the pins to ensure you make the correct connection.

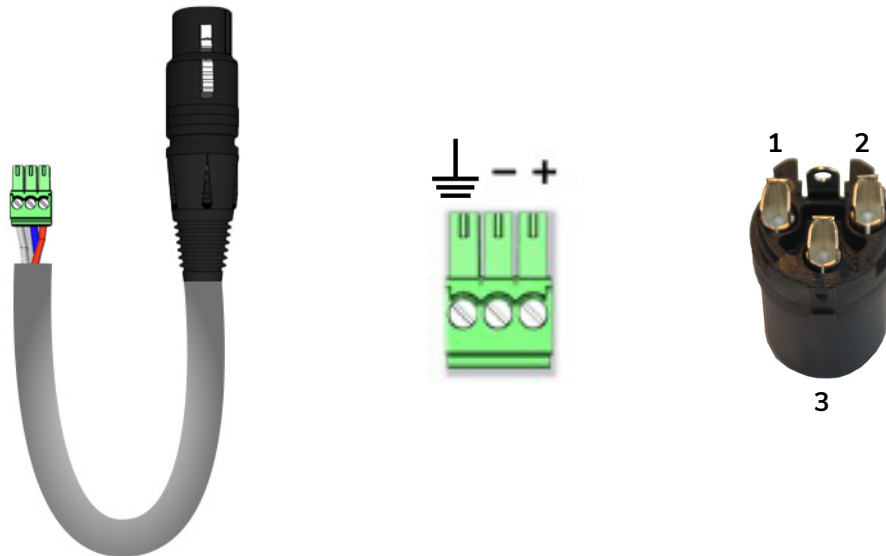

For microphones and remote (balanced) line inputs on Zone and SmartAmp products:

- 1 x Euroblock 3.5mm pitch 3 pin
- 1 x XLR female in-line connector
- 2 core and screen standard signal cable

	Connect these pins		
Euroblock		-	+
XLR	1	3	2

USER GUIDE

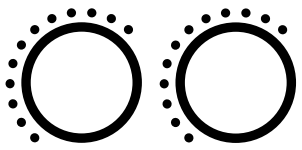

Controllers

Zone 8 & 8P

8 zone audio controller with DSP and WebApp

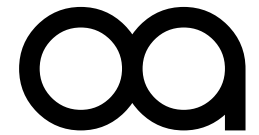

Optimal Audio

Connecting Unbalanced Audio Equipment

For unbalanced line inputs you'll need RCA connectors. The inputs on Zone are stereo, so you can use paired cables off the shelf.

It's always worth avoiding cheap RCA connectors, so make sure you go for something robust, with solid centre pins and preferably a steel outer casing.

If you are going to make up your own cables, again it's important to observe the correct wiring convention. Use high quality, flexible coaxial audio cable. The centre core connects to the centre pin, and the outer screen to the outer sleeve.



For local line inputs on Zone products:

RCA phono connectors

Use these for equipment situated close to your Zone – streamers, CD players, phones, laptops etc.

USER GUIDE

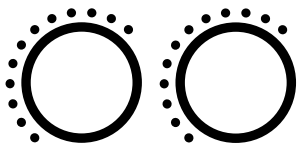

Controllers

Zone 8 & 8P

8 zone audio controller with DSP and WebApp

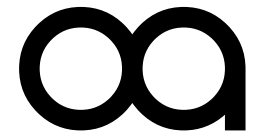

Optimal Audio

Connecting Laptops, Tablets and Phones to Zone Unbalanced Inputs

Most laptops have built-in HDMI ports. We recommend using these for an audio connection to a Zone.

Tablets and mobile phones have a standard 3.5mm jack headphone output, or an adapter that will convert to 3.5mm jack. MP3 players, many phones and other domestic audio sources use them too. Again, these cables are readily available from cable suppliers and home electronics stores.

If making your own, make sure that you get the left and right signal wires on the correct pins in both the jack plug and the RCA cables. Be careful not to short out any of the terminals in either connector.



For local line inputs on Zone products: RCA connectors to 3 pole (TRS) jack – 3.5mm or 6.35mm size

For connection of laptops and other equipment with stereo jack outputs using standard mic cable.

Note the wiring – very important!

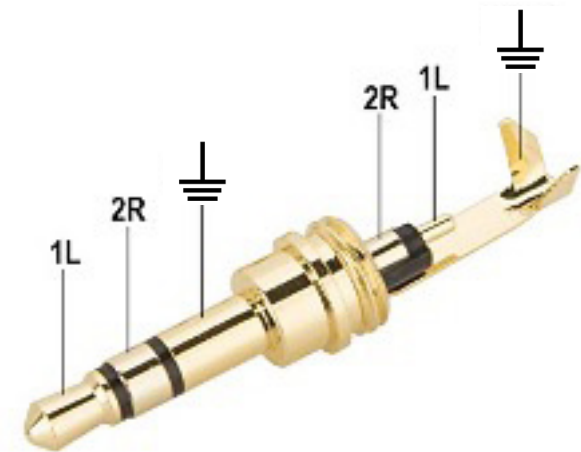

	Connect these pins		
RCA Left	Centre pin		Sleeve
RCA Right		Centre pin	Sleeve
Jack	Tip	Ring	Sleeve

USER GUIDE

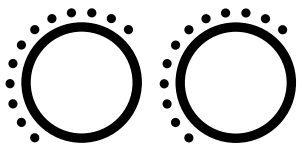

Controllers

Zone 8 & 8P

8 zone audio controller with DSP and WebApp

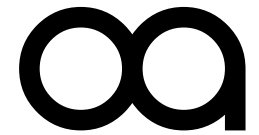

Optimal Audio

Connecting AV Equipment to Zone HDMI Inputs

Inputs 5 and 6 on all Zone products need Type A standard HDMI connectors. These are readily available either online or in consumer electronics stores.

Be sure to identify the correct type of HDMI connector on the equipment you are plugging in – there are three types of HDMI connector – Standard, Mini and Micro – they are all compatible with each other



Line inputs 5 and 6 on all Zone products require standard HDMI connectors

USER GUIDE

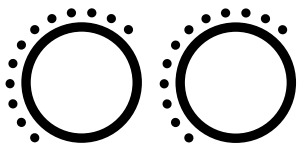

Controllers

Zone 8 & 8P

8 zone audio controller with DSP and WebApp

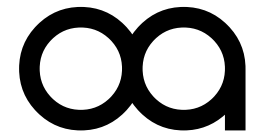

Optimal Audio

Line Outputs

Zone 8 and 8P have eight balanced outputs for external amplifiers that can be configured as mono or stereo as required, within WebApp. Use the Euroblock connectors supplied with the unit. Wiring conventions are clearly marked on the rear of the unit. Wiring conventions are clearly marked on the rear of the unit.



USER GUIDE

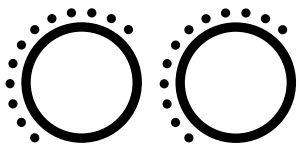

Controllers

Zone 8 & 8P

8 zone audio controller with DSP and WebApp

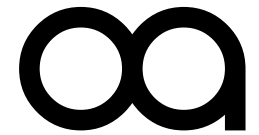

Optimal Audio

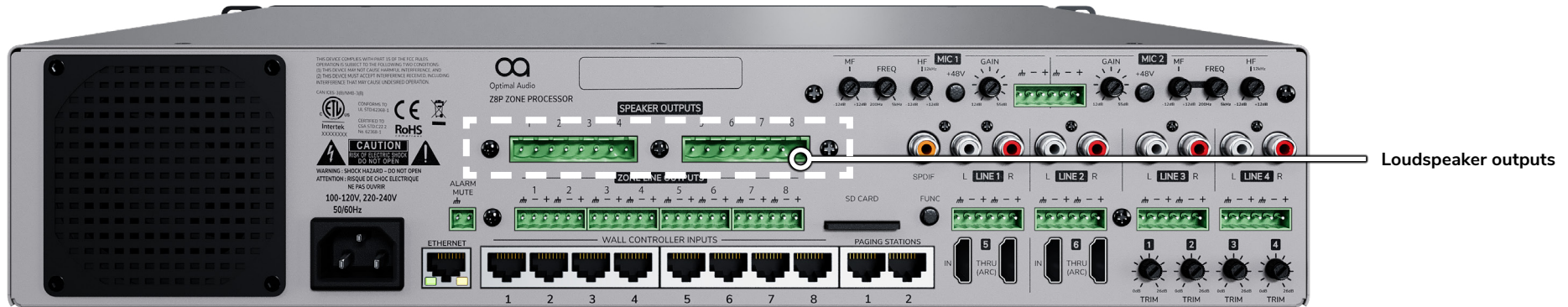

Loudspeaker Outputs (Zone 8P only)

The Zone 8P's integrated amplifier allows you to run one 4 ohm, two 8 ohm or four 16 ohm loudspeakers on each output. It will deliver a total of 100W of power into the loudspeakers on each output.

The speaker outputs from the internal amplifiers in Zone 8P use 5mm pitch Euroblock connectors, which are supplied with the unit. It's critical that all loudspeakers are wired to the correct polarity. All Zone products have the negative pin first and then positive.

All Optimal Audio loudspeakers have clear labels that show which terminal is which.

Bridge Mode

The speaker outputs will deliver up to 100W into an 8Ω load. Adjacent pairs can be configured to run in bridged mode within WebApp, delivering up to 200W into 8Ω or suitably tapped 70V line loudspeakers.

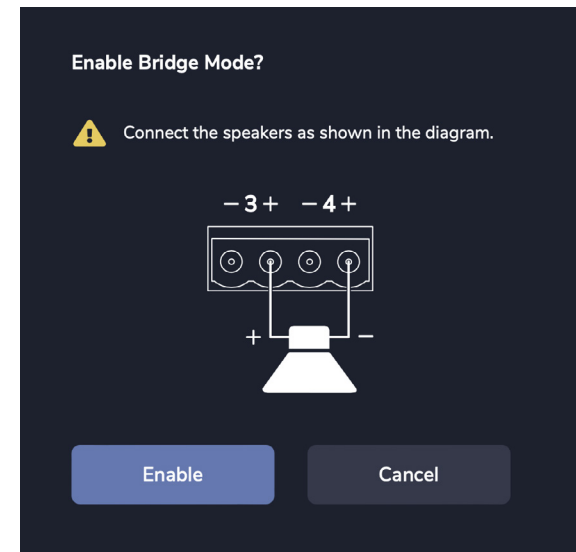

USER GUIDE

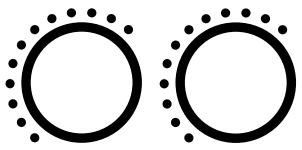

Controllers

Zone 8 & 8P

8 zone audio controller with DSP and WebApp

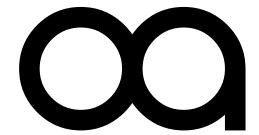

Optimal Audio

Speaker Connections

The speaker outputs from the internal amplifiers in Zone 8P use 5mm pitch Euroblock connectors, which are supplied with the unit. Make sure you get the connector the right way up when plugging in.

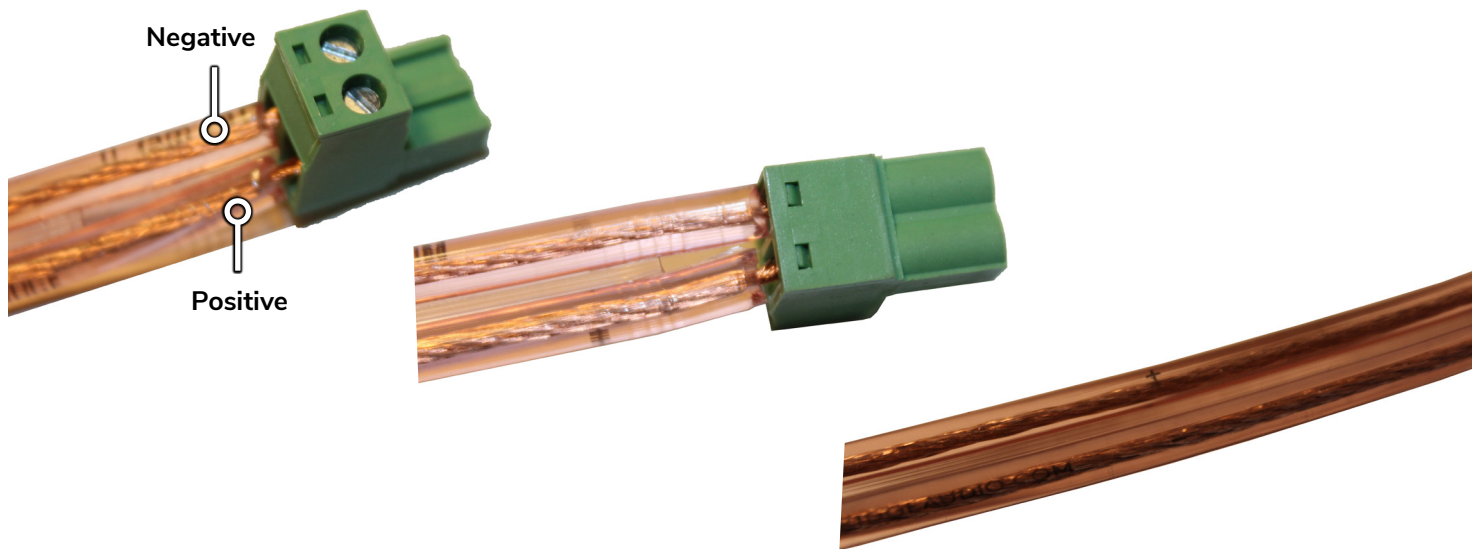

Zone 4P and 8P have
loudspeaker connectors

Use the supplied Euroblock
connector with the 5mm pitch
between terminals

Be sure to wire up + and -
correctly

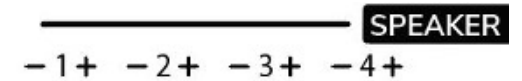

USER GUIDE

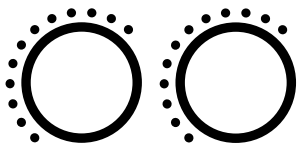

Controllers

Zone 8 & 8P

8 zone audio controller with DSP and WebApp

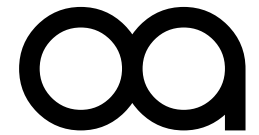

Optimal Audio

ZonePad Wall controllers

ZonePad wall controllers have been designed to mirror essential elements of the front panel of Zone. The difference between them is that ZonePad 1 has only source selectors as it controls only a single zone. ZonePad 4 has the same selectors as a Zone 4 or 4P – choose your zone on the left and source on the right.

In both cases ZonePad 1 and ZonePad 4 have a central button to select a source that is locally connected to the panel. The button is labelled 'Local source'.

The button in the centre of the volume knob switches the operation between level control of the selected music source and the local mic. Push to toggle between the two level controls.



USER GUIDE

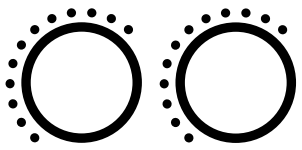

Controllers

Zone 8 & 8P

8 zone audio controller with DSP and WebApp

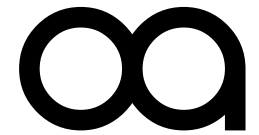

Optimal Audio

Paging stations

These connections are for a future product and can be used to connect a ZonePad 4.

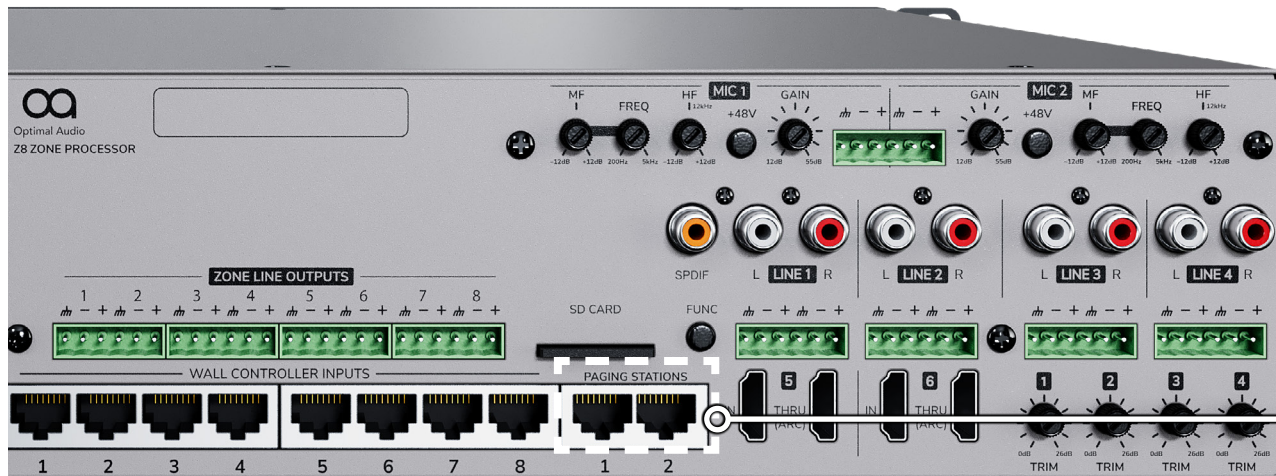

Paging station connections

USER GUIDE

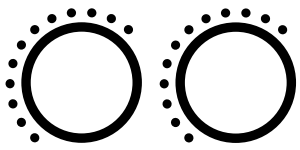

Controllers

Zone 8 & 8P

8 zone audio controller with DSP and WebApp

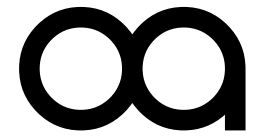

Optimal Audio

Alarm Override

To connect an override from a fire alarm system, use the Euroblock connector positioned to the left of the Line Outputs. Contact close between the two terminals will mute all outputs. When alarm override is enabled the power light will change to orange and a status bar will appear in WebApp.

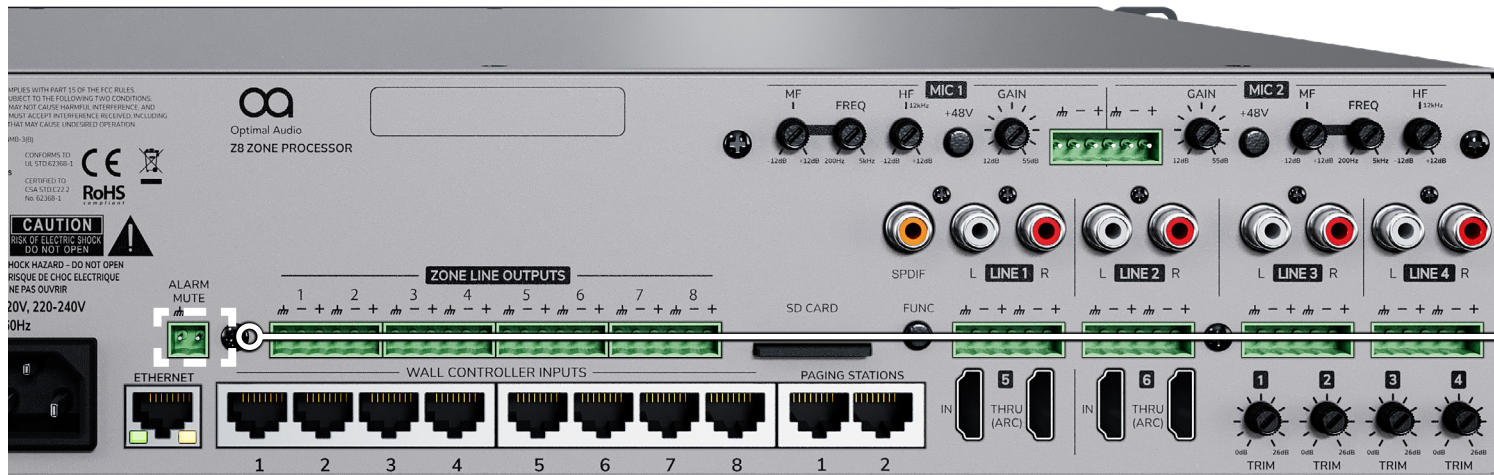

Alarm override

USER GUIDE

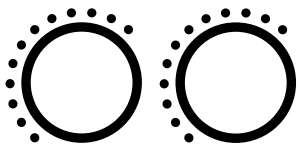

Controllers

Zone 8 & 8P

8 zone audio controller with DSP and WebApp

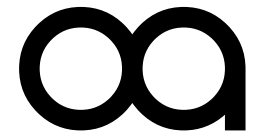

Optimal Audio



WARNING!

DO NOT EXPOSE THIS EQUIPMENT TO RAIN OR MOISTURE

This symbol is intended to alert the user to the presence of important operating and maintenance (servicing) instructions in the literature accompanying the appliance.



CAUTION

**RISK OF ELECTRIC SHOCK
DO NOT OPEN**

This symbol is intended to alert the user to the presence of uninsulated "dangerous voltage" within the product's enclosure that may be of sufficient magnitude to constitute a risk of electric shock to persons.

THIS EQUIPMENT MUST BE EARTHED

Important Safety Instructions

1. Read these instructions.
2. Keep these instructions.
3. Heed all warnings.
4. Follow all instructions.
5. Do not use this apparatus near water.
6. Clean only with a dry cloth.
7. Do not block any ventilation opening. Install in accordance with the manufacturer's instructions.
8. Do not install near any heat sources such as radiators, heat registers, stoves, or other apparatus (including amplifiers) that produce heat.
9. To reduce the risk of electrical shock, the power cord shall be connected to a mains socket outlet with a protective earthing connection.
10. Do not defeat the safety purpose of the polarized or grounding type plug. A polarized plug has two blades with one wider than the other. A grounding type plug has two blades and a third grounding prong. The wide blade or the third prong are provided for your safety. If the provided plug does not fit into your outlet, consult an electrician for replacement of the obsolete outlet.
11. Protect the power cord from being walked on or pinched particularly at plugs, convenience receptacles, and the point where they exit from the apparatus.
12. Do not unplug the unit by pulling on the cord, use the plug.
13. Unplug this apparatus during lightning storms or when unused for long periods of time.
14. Refer all servicing to qualified service personnel. Servicing is required when the apparatus has been damaged in any way, such as power supply cord or plug is damaged, liquid has been spilled or objects have fallen into the apparatus, the apparatus has been exposed to rain or moisture, does not operate normally, or has been dropped.
15. The appliance coupler, or the AC Mains plug, is the AC mains disconnect device and shall remain readily accessible after installation.
16. The apparatus shall not be exposed to dripping or splashing and no objects filled with liquids, such as vases, shall be placed on the apparatus.
17. Do not remove any covers, loosen any fixings or allow items to enter any aperture.

FCC Compliance

This device complies with part 15 of the FCC Rules. Operation is subject to the following two conditions:

1. This device may not cause harmful interference.
2. This device must accept any interference received, including interference that may cause undesired operation.

Note: This equipment has been tested and found to comply with the limits for a Class B digital device, pursuant to part 15 of the FCC Rules. These limits are designed to provide reasonable protection against harmful interference in a residential installation. This equipment generates uses and can radiate radio frequency energy and, if not installed and used in accordance with the instructions, may cause harmful interference to radio communications.

USER GUIDE

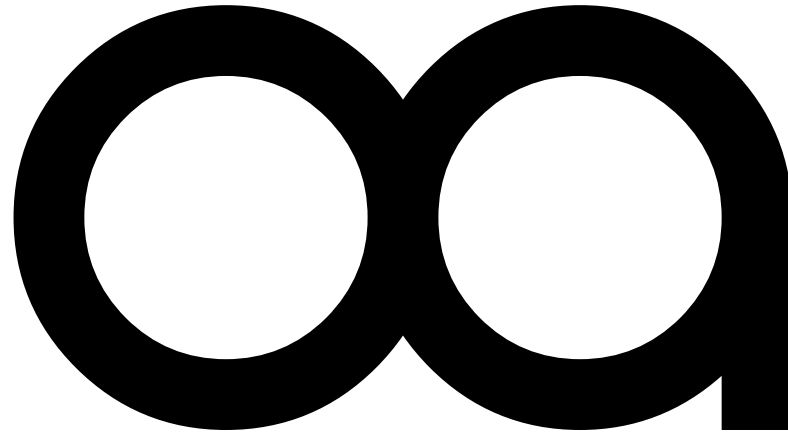

Relax, It's Optimal Audio.

optimal-audio.co.uk

Optimal Audio Group Ltd.
Century Point, Halifax Road,
Cressex Business Park,
High Wycombe,
Buckinghamshire,
HP12 3SL